

HI 3000 Series

Operation and Installation Manual

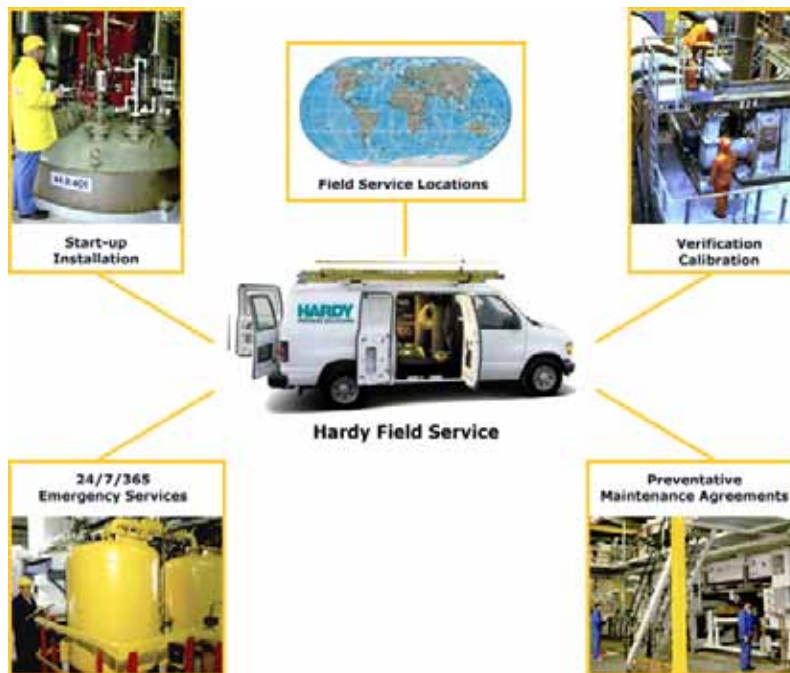

Hardy Process Solutions Document Number: 0596-0258-01 Rev P



Local Field Service

Hardy has over 200 field technicians in the U.S., and more positioned throughout the world to assist you in your support needs. We also have factory engineers who will travel to your facility anywhere in the world to help you solve challenging applications. We're ready to support you with:

- **Installation and start-up**
- **Routine maintenance and certification**
- **Plant audits and performance measurement**
- **Emergency troubleshooting and repair**

To request Emergency Service and Troubleshooting, Start-up, Installation, Calibration, Verification or to discuss a Maintenance Agreement please call **800-821-5831 Ext. 1757** or Emergency Service after hours (Standard Hours 6:00 AM to 6:00 PM Pacific Standard Time) and weekends Ext. 1111.

Outside the U.S

Hardy Process Solutions has built a network of support throughout the globe. For specific field service options available in your area please contact your local sales agent or our U.S. factory at **+1 858-292-2710, Ext. 1757**.

Table of Contents

Table of Contents	----- i
Table of Illustrations	----- i
Communications	
	Installation & Operation ----- 1
Overview	----- 1
DeviceNet™	----- 1
Hardy Control-Link TCP/IP (Ethernet)	----- 1
PRS-232 Simplex Serial Port	----- 1
Communication Option Cards	----- 1
Remote I/O	----- 1
ControlNet	----- 2
Profibus	----- 2
MOD-Bus/TPC/IP	----- 2
OPC	----- 2
EtherNet/IP™	----- 3
Allen-Bradley Remote I/O	----- 3
Allen-Bradley License	----- 3
Common Applications	----- 3
Monitoring Weighing Parameters	----- 4
Short Glossary of Terms	----- 4
Tare Value	----- 4
Remote I/O Board Cable Termination Dip Switch Configuration	----- 4
About Cable Termination	----- 4
Dip Switch Settings	----- 4
Installing the RIO Option Board	----- 4
Connector Pin Out	----- 5
LED Indicators	----- 5
Removing the Remote I/O Option Card	----- 5
Remote I/O Configuration Procedures from the Front Panel	----- 5
Remote I/O Configuration Procedures from the Web Page	----- 7
Discrete Remote I/O Mapping	----- 9
About Discrete Remote I/O Mapping	----- 9
General Information	----- 9
For Reads:	----- 9
Mapping	----- 10
Cabling	
	Installation ----- 11
General Introduction to Cabling	----- 11
Unpacking	----- 11
Input Power Wiring	----- 11
Digital Input Wiring	----- 11
Output Relay Wiring	----- 12
Load Point Connections	----- 12
C2® Load Point Connection	----- 12
Non-C2 Load Cell Connection	----- 12
RS 232 Connection	----- 12
RS 232 Connection Pinout	----- 13
-JB Option Wiring	----- 13
Ethernet Cable Connection and Setup	----- 13
Setting the IP Address for the Blind Remote	----- 15
Setting or Changing the IP Address using the Ethernet	----- 15
DeviceNet Connection and Setup From the Front Panel	----- 16
For HI 3010 Only	----- 16
For HI 3030, HI 3600, HI 3300	----- 17

ControlNet Option Card Installation	18
Removing the ControlNet Option Card	19
ControlNet Connection and Setup	19
Hardware Requirements:	19
Software Requirements:	19
Setting the ControlNet Node Address from the Front Panel	20
Activating ControlNet and Setting the ControlNet Node Address from the Web Page	20
LED Status Indicators	22
EtherNet/IP™ Option Card Installation	22
Removing the EtherNet/IP Option Card	23
Setting Up the EtherNet I/P Address from the Front Panel	23
Setting Up the EtherNet I/P Address from the Web Page	24
LED Status Indicators	25
LED 1 - Link (Activity)	25
LED 2 - Module Status	25
LED 3 - Network Status	26
LED 4 - Activity	26
Profibus Option Card Installation	26
Profibus Connection and Setup	26
Hardware Requirements:	26
Software Requirements:	26
Cabling Guidelines	26
Cable Specification	27
LED Indicators	28
Removing the Profibus Option Card	28
Analog Output Option Card Installation	28
Electrical Connection	29
Removing the Analog Option Card	29
Rear Cover Installation (HI 3000-RC)	29
Removing the NEMA 4 Plug	30
Installing the NEMA 4 Plug	30
Installing the Cord Grip Assemblies	30
Removing the Cord Grip Assembly	32
Installing the HI 3000-RC Rear Cover	32
Network	
Installation	35
About Networks	35
Simple Ethernet Network	35
Materials Required	35
Hardy Control-Link Ethernet Network	37
Materials Required	37
Setting Node Addresses for HI 3000 Series Instruments from the Browser	38
Using the Ping Tool	40
DeviceNet Network Setup	41
RSNetWorx Setup for HI 3000 Series Instruments	41
Slave Mode Setup	43
Building a Scanlist in RSNetWorx	45
ControlNet Network Setup	46
RSNetWorx Setup for HI 3000 Series Instruments with ControlNet Option Card	46
Schedule the Network Using RSNetWorx for ControlNet	47
Verify the Network Properties	47
Survey the Network for Connected Devices	47
Schedule the Network and Save the Configuration	47
Selecting the ControlNet Node Address from the Front Panel	47
Selecting the ControlNet Node Address from the Web Page	48

	PROFIBUS-DP Network Setup - - - - -	49
	Initialization Process - - - - -	49
	Profibus-DP .GSD File - - - - -	49
	Pre-Initialization Procedures - - - - -	49
	Initialization Procedures - - - - -	50
	Selecting the Profibus Node Address from the Front Panel - - - - -	52
	Selecting the Profibus Node Address from the Web Page - - - - -	53
	MODBUS - TCP/IP Over Ethernet - - - - -	54
	About MODBUS/TCP/IP Over Ethernet - - - - -	54
	Installing MODBUS - - - - -	55
	Enabling MODBUS in the HI 3000 Module - - - - -	55
	Installing Hardy Modbus-Link - - - - -	56
	Using MODBUS with Excel® - - - - -	60
	OPC Network Setup - - - - -	60
	OPC SERVER - - - - -	61
	Configuring Omniserver to Communicate with an HI 3000 Module - - - - -	61
	Setting Up OPC Communication with a Client - - - - -	72
	About OPC Clients - - - - -	72
	Setting up the Output to the OPC Server and the Client from the HI 3000 Module - - - - -	77
	Adding the HI 3000 Module to the Hardy Control-Link (TCP/IP) Network - - - - -	77
	Mapping Parameters to the HardyFloat Output Table - - - - -	79
	Configuring EtherNet/IP Using RSLogix5000® - - - - -	83
	Mapping - - - - -	85
E-Mail	Configuration and Operation - - - - -	87
	Overview - - - - -	87
	Understanding IP Addresses - - - - -	87
	Glossary of E-Mail Terms - - - - -	87
	Gateway - - - - -	87
	SMTP - - - - -	88
	DNS - - - - -	88
	POP - - - - -	88
	Configuring the E-Mail Server - - - - -	88
	Entering the Mail Server Name from the Front Panel - - - - -	89
	Continuing E-Mail Configuration from the Web Page - - - - -	90
	Configuring Standard E-Mail - - - - -	90
	Configuring Custom E-Mail - - - - -	91
	About Custom E-Mail - - - - -	91
	About Tokens - - - - -	91
	Testing E-Mail - - - - -	94
	Setting up Filters in E-mail Applications - - - - -	95
Security	Setup - - - - -	97
	Overview - - - - -	97
	Security Levels - - - - -	97
	Setting up Passwords from the Front Panel - - - - -	97
	Setting up Passwords from the Browser - - - - -	98
	Log On Procedures - - - - -	99
	Logging on from the Front Panel - - - - -	99
	Log On from the Browser - - - - -	100
	Log Off Procedures from the Front Panel - - - - -	100
HI 3001	Master Display - - - - -	103
	Overview - - - - -	103
	Getting Started - - - - -	103
	Help - - - - -	103

About Help	- - - - -	103
Front Panel Display	- - - - -	103
Button Functions	- - - - -	103
Start Button	- - - - -	103
Stop Button	- - - - -	103
Help Button	- - - - -	103
Station Button	- - - - -	103
Buttons Button	- - - - -	104
Setup/3/DEF Button	- - - - -	104
Test/9/WXYZ Button	- - - - -	104
Setting the IP Address	- - - - -	104
Installing the HI 3001	- - - - -	104
Selecting an Instrument on the Network	- - - - -	104
Software Downloads for HI 3000 Series	- - - - -	104

Glossary of terms

Index

Table of Illustrations

Communications	<p>Installation & Operation - - - - - 1</p> <p>FIG. 1 CONTROLNET ARCHITECTURE - - - - - 2</p> <p>FIG. 2 ETHERNET/IP™ NETWORK - - - - - 3</p> <p>FIG. 3 TERMINATING SWITCH FOR TERMINATING LAST MODULE - - - 4</p> <p>FIG. 4 REMOTE I/O OPTION CARD - - - - - 4</p> <p>FIG. 5 REMOTE I/O/SLIDE INTO OPTION SLOT #0 - - - - - 5</p> <p>FIG. 6 REMOTE I/O OPTION CARD INSTALLED - - - - - 5</p> <p>FIG. 7 CONFIGURATION MENU/SELECTING SETUP - - - - - 5</p> <p>FIG. 8 CONFIGURATION MENU/SELECTING OPTIONS - - - - - 6</p> <p>FIG. 9 OPTIONS/SELECTING REMOTE I/O - - - - - 6</p> <p>FIG. 10 REMOTE I/O MENU/SETTING PARAMETERS - - - - - 6</p> <p>FIG. 11 REMOTE I/O/SETTING RACK SIZE - - - - - 6</p> <p>FIG. 12 REMOTE I/O SELECTING STARTING QUARTER - - - - - 6</p> <p>FIG. 13 INSTRUMENT HOME PAGE/SELECTING CONFIGURATION - - - 7</p> <p>FIG. 14 CONFIGURATION - OPTIONS PAGE/SELECTING VIEW REMOTE I/O CONFIGURATION - - - - - 7</p> <p>FIG. 15 REMOTE I/O CONFIGURATION PAGE - - - - - 7</p> <p>FIG. 16 REMOTE I/O CONFIGURATION/SELECTING BAUD RATE - - - - 7</p> <p>FIG. 17 REMOTE I/O CONFIGURATION/SELECTING RACK SIZE - - - - 8</p> <p>FIG. 18 REMOTE I/O CONFIGURATION/SELECTING QUARTER - - - - - 8</p> <p>FIG. 19 REMOTE I/O CONFIGURATION/SELECTING LAST QUARTER - - 8</p>
Cabling	<p>Installation - - - - - 11</p> <p>FIG. 20 POWER WIRING DIAGRAM - - - - - 11</p> <p>FIG. 21 POWER SUPPLY BOARD REAR PANEL - - - - - 11</p> <p>FIG. 22 DRY CONTACT WIRING DIAGRAM - - - - - 12</p> <p>FIG. 23 REAR PANEL/LOAD POINT CONNECTIONS - - - - - 12</p> <p>FIG. 24 SERIAL PORT CONNECTION - - - - - 13</p> <p>FIG. 25 -JB OPTION CONNECTIONS - - - - - 13</p> <p>FIG. 26 REAR PANEL/ETHERNET RJ 45 CONNECTION - - - - - 13</p> <p>FIG. 27 CONFIGURATION MENU/SELECTION SETUP - - - - - 14</p> <p>FIG. 28 SETUP MENU - - - - - 14</p> <p>FIG. 29 SETUP MENU/ETHERNET SUB-MENU - - - - - 14</p> <p>FIG. 30 ETHERNET MENU/DEFAULT IP ADDRESS - - - - - 14</p> <p>FIG. 31 ENTER IP ADDRESS IN BROWSER ADDRESS FIELD - - - - - 14</p> <p>FIG. 32 WEB PAGE - - - - - 15</p> <p>FIG. 33 INSTRUMENT WEB PAGE - - - - - 15</p> <p>FIG. 34 IP SETUP MENU - - - - - 15</p> <p>FIG. 35 IP SETUP/SETTING NEW ADDRESS - - - - - 15</p> <p>FIG. 36 NEW IP ADDRESS IS RESET - - - - - 16</p> <p>FIG. 37 REAR PANEL/DEVICENET CONNECTION - - - - - 16</p> <p>FIG. 38 CONFIGURATION MENU/SELECTING SETUP - - - - - 16</p> <p>FIG. 39 SETUP MENU/SELECTING DEVICENET - - - - - 16</p> <p>FIG. 40 DEVICENET SUB-MENU/SETTING THE BAUD RATE - - - - - 16</p> <p>FIG. 41 DEVICENET/SELECTING NODE ADDRESS - - - - - 17</p> <p>FIG. 42 CONFIGURATION MENU/SELECTING SETUP - - - - - 17</p> <p>FIG. 43 CONFIGURATION MENU - - - - - 17</p> <p>FIG. 44 OPTIONS MENU/SELECTING DEVICENET I/O - - - - - 17</p> <p>FIG. 45 DEVICENET SUB-MENU/SETTING THE BAUD RATE - - - - - 17</p> <p>FIG. 46 DEVICENET/SELECTING NODE ADDRESS - - - - - 18</p> <p>FIG. 47 CONTROLNET/OPTION CARD - - - - - 18</p> <p>FIG. 48 CONTROLNET/SLIDE INTO OPTION SLOT #0 - - - - - 18</p> <p>FIG. 49 CONTROLNET OPTION CARD INSTALLED - - - - - 19</p> <p>FIG. 50 CONTROLNET CABLE ASSEMBLIES - - - - - 19</p> <p>FIG. 51 ROTARY SWITCHES/SETTING NODE ADDRESS TO 0, 0 - - - - 19</p>

FIG. 52 REAR PANEL CONTROLNET CONNECTORS AND LEDS - - - - - 19

FIG. 53 CONFIGURATION MENU/SELECTING SETUP - - - - - 20

FIG. 54 CONFIGURATION MENU/SELECTING OPTIONS - - - - - 20

FIG. 55 OPTIONS/SELECTING CONTROLNET I/O - - - - - 20

FIG. 56 CONTROLNET I/O MENU/SETTING NODE ADDRESS - - - - - 20

FIG. 57 HOME PAGE/SELECTING CONFIGURATION - - - - - 20

FIG. 58 CONFIGURATION PAGE/SELECTING OPTIONS - - - - - 21

FIG. 59 OPTIONS PAGE/SELECTING VIEW CONTROLNET
 CONFIGURATION - - - - - 21

FIG. 60 CONTROLNET PAGE/ACTIVATING CONTROLNET - - - - - 21

FIG. 61 CONTROLNET CONFIGURATION PAGE/ENTERING
 NODE ADDRESS - - - - - 21

FIG. 62 CONTROLNET CONFIGURATION/ENTERING NODE
 ADDRESS - - - - - 22

FIG. 63 ETHERNET I/P/OPTION CARD - - - - - 23

FIG. 64 ETHERNET/I/P/SLIDE INTO OPTION SLOT #0 - - - - - 23

FIG. 65 ETHERNET/IP OPTION CARD INSTALLED - - - - - 23

FIG. 66 CONFIGURATION MENU/SELECTING OPTIONS - - - - - 24

FIG. 67 OPTIONS/SELECTING ETHERNET/IP I/O - - - - - 24

FIG. 68 ETHERNET/IP MENU/SETTING IP ADDRESS - - - - - 24

FIG. 69 HI 3000 HOME PAGE/SELECTING CONFIGURATION - - - - - 24

FIG. 70 CONFIGURATION PAGE/SELECTING OPTIONS - - - - - 25

FIG. 71 OPTIONS PAGE/SELECTING VIEW ETHERNET/IP
 CONFIGURATION - - - - - 25

FIG. 72 ETHERNET/IP PAGE/SETTING IP ADDRESS - - - - - 25

FIG. 73 CONNECTOR/DIP SWITCHES/LEDS - - - - - 25

FIG. 74 PROFIBUS DB9 SERIAL CONNECTOR WITH SLIDE
 SWITCH/MALE - - - - - 26

FIG. 75 DB9 CONNECTOR ON THE HARDY PROFIBUS OPTION CARD - - 27

FIG. 76 ROTARY SWITCHES/SETTING NODE ADDRESS TO 0, 0 - - - - 27

FIG. 77 LED INDICATORS - - - - - 28

FIG. 78 ANALOG OUTPUT OPTION 2AN - - - - - 29

FIG. 79 INSTALLING THE ANALOG OPTION CARD IN A 3000 CHASSIS - 29

FIG. 80 ANALOG ELECTRICAL CONNECTIONS - - - - - 29

FIG. 81 NEMA 4X REAR COVER - - - - - 30

FIG. 82 INSTALLING NEMA 4 PLUG - - - - - 30

FIG. 83 INSTALLING THE HEX NUT ONTO THE CORD GRIP ASSEMBLY - 30

FIG. 84 CORD GRIP INSTALLED - - - - - 31

FIG. 85 INSTALLING THE HEX NUT ONTO THE CORD GRIP ASSEMBLY - 31

FIG. 86 CORD GRIP INSTALLED - - - - - 31

FIG. 87 INSTALLING CABLES IN THE CORD GRIP ASSEMBLY - - - - 32

FIG. 88 ALIGNING THE REAR COVER TO THE CHASSIS - - - - - 32

FIG. 89 REAR COVER, NEMA 4 PLUGS, AND CORD GRIPS INSTALLED - 33

Network

Installation - - - - - 35

FIG. 90 SIMPLE HARDY CONTROL-LINK NETWORK - - - - - 35

FIG. 91 IP ADDRESS CONFIGURATION - - - - - 35

FIG. 92 CONTROL PANEL - - - - - 36

FIG. 93 NETWORK DIALOG BOX/SELECT TCP/IP - - - - - 36

FIG. 94 NETWORK DIALOG BOX/SELECT PROPERTIES - - - - - 37

FIG. 95 TCI/IP PROPERTIES/IP ADDRESS - - - - - 37

FIG. 96 INTERNET PROPERTIES DIALOG BOX - - - - - 37

FIG. 97 HARDY CONTROL-LINK ETHERNET NETWORK - - - - - 37

FIG. 98 FILLER/DISPENSER HOME PAGE/SELECTING
 CONFIGURATION - - - - - 38

FIG. 99 CONFIGURATION PAGE/SELECTING HARDY CONTROL-LINK - - 38

FIG. 100 CONFIGURATION - HARDY CONTROL-LINK PAGE - - - - - 38

FIG. 101 CONFIGURATION - HARDY CONTROL-LINK/INSTRUMENT SELECTION PULL DOWN LIST - - - - - 39

FIG. 102 CONFIGURATION PAGE WITH INSTRUMENTS NOT ASSIGNED A NODE ADDRESS - - - - - 39

FIG. 103 SELECTED INSTRUMENT WITH IP ADDRESS IN IP ADDRESS FIELD - - - - - 39

FIG. 104 HI-3010 (IP ADDRESS 192.168.110.68) ASSIGNED TO NODE 0 - - - 39

FIG. 105 SELECTED INSTRUMENT WITH IP ADDRESS IN IP ADDRESS FIELD - - - - - 39

FIG. 106 HI-3010 (IP ADDRESS 192.168.110.24) ASSIGNED TO NODE 1 - - - 40

FIG. 107 INSTRUMENTS ASSIGNED TO NODE 0 THROUGH NODE 7 - - - 40

FIG. 108 SAVING THE CONFIGURATION - - - - - 40

FIG. 109 TRANSFERRING THE NODE CONFIGURATION FROM NODE 0 TO NODE 1 - - - - - 40

FIG. 110 SELECTING EDS WIZARD - - - - - 41

FIG. 111 EDS WIZARD DIALOG BOX - - - - - 41

FIG. 112 SELECTING "REGISTER AN EDS FILE" - - - - - 41

FIG. 113 SELECTING THE HARDY EDS FILE - - - - - 41

FIG. 114 SELECTING THE HARDY EDS FILE - - - - - 42

FIG. 115 EDS FILE INSTALLATION TEST RESULTS DIALOG BOX - - - - - 42

FIG. 116 CHANGE GRAPHIC IMAGE DIALOG BOX - - - - - 42

FIG. 117 FINAL TASK SUMMARY DIALOG BOX - - - - - 42

FIG. 118 HARDWARE/VENDOR/HARDY INSTRUMENTS INC. INSTALLED - 43

FIG. 119 GRAPH/HARDY FILLER ICON - - - - - 43

FIG. 120 MODULE TAB/SELECTING SLAVE MODE - - - - - 43

FIG. 121 SLAVE MODE DIALOG BOX - - - - - 43

FIG. 122 INPUT PAGE/SELECTING AUTOMAP - - - - - 44

FIG. 123 INPUT PAGE/INPUTS MAPPED - - - - - 44

FIG. 124 OUTPUT PAGE/SELECTING AUTOMAP - - - - - 44

FIG. 125 OUTPUT PAGE/OUTPUTS MAPPED - - - - - 44

FIG. 126 GRAPH OF NETWORKED MODULES - - - - - 45

FIG. 127 HARDY FILLER PROPERTIES LIST - - - - - 45

FIG. 128 SCANLIST PAGE/AVAILABLE DEVICES - - - - - 45

FIG. 129 SCANLIST PAGE/SCANLIST - - - - - 46

FIG. 130 INPUT PAGE/CHANGE PARAMETERS - - - - - 46

FIG. 131 CONFIGURATION MENU/SELECTING SETUP - - - - - 47

FIG. 132 CONFIGURATION MENU/SELECTING OPTIONS - - - - - 48

FIG. 133 OPTIONS/SELECTING REMOTE I/O - - - - - 48

FIG. 134 CONTROLNET I/O MENU/SELECTING THE NODE ADDRESS - - - 48

FIG. 135 ELECTING CONFIGURATION FROM THE HOME PAGE OF THE HI 3000 INSTRUMENT - - - - - 48

FIG. 136 CONFIGURATION PAGE/SELECTING OPTIONS - - - - - 48

FIG. 137 CONFIGURATION - OPTIONS/SELECTING VIEW CONTROLNET CONFIGURATION OPTION - - - - - 49

FIG. 138 CONTROLNET CONFIGURATION PAGE/SELECTING THE NODE ADDRESS - - - - - 49

FIG. 139 PROFIBUS LOGO - - - - - 49

FIG. 140 SIMPLE PROFIBUS NETWORK WITH TRUNK AND DROP LINES - 49

FIG. 141 HARDWARE CATALOG/SELECTING ANYBUS-S PDP FOLDER - - 50

FIG. 142 ANYBUS-S PDP PARAMETERS DIALOG BOX - - - - - 50

FIG. 143 SELECTING THE INPUT AND OUTPUT SIZE - - - - - 51

FIG. 144 ANYBUS-S PDP APPEARS IN THE NETWORK - - - - - 51

FIG. 145 DOWNLOADING HI 3000 SERIES CONFIGURATION - - - - - 51

FIG. 146 SELECT DESTINATION MODULE DIALOG BOX - - - - - 52

FIG. 147 SELECT STATION ADDRESS DIALOG BOX 52

FIG. 148 DOWNLOADING CONFIGURATION PROMPT - - - - - 52

FIG. 149 INITIALIZATION COMPLETE - - - - - 52

FIG. 150 CONFIGURATION MENU/SELECTING SETUP	52
FIG. 151 CONFIGURATION MENU/SELECTING OPTIONS	53
FIG. 152 OPTIONS/SELECTING PROFIBUS I/O	53
FIG. 153 PROFIBUS I/O MENU/SELECTING THE NODE ADDRESS	53
FIG. 154 SELECTING CONFIGURATION FROM THE HOME PAGE OF THE HI 3000 INSTRUMENT	53
FIG. 155 CONFIGURATION PAGE/SELECTING OPTIONS	53
FIG. 156 CONFIGURATION - OPTIONS/SELECTING VIEW PROFIBUS CONFIGURATION OPTION	54
FIG. 157 PROFIBUS CONFIGURATION PAGE/SELECTING THE NODE ADDRESS	54
FIG. 158 MODBUS COMMUNICATION DIAGRAM	55
FIG. 159 MACHINE MONITOR/SELECTING CONFIGURATION	55
FIG. 160 CONFIGURATION/SELECTING OPTIONS	55
FIG. 161 CONFIGURATION - OPTIONS/SELECTING MODBUS	55
FIG. 162 MODBUS - OPTIONS PAGE	55
FIG. 163 MODBUS - OPTIONS/ENABLED]	56
FIG. 164 HARDY MODBUS-LINK DISPLAY	56
FIG. 165 HARDY MODBUS-LINK/SELECTING CONNECT	56
FIG. 166 TCP/IP CONNECTION DISPLAY	57
FIG. 167 TCP/IP CONNECTION DISPLAY/SELECTING TCP/IP	57
FIG. 168 TCP/IP CONNECTION DISPLAY/ENTERING THE IP ADDRESS	57
FIG. 169 MAPPING DISPLAY/CLICKING ON DESTINATION - SCRATCHPAD: HFO4 (HARDY FLOAT OUT - WORD 4)	57
FIG. 170 MAPPING DISPLAY/SELECTING DESTINATION - SCRATCHPAD: HFO4	57
FIG. 171 MAPPING DISPLAY/SELECTING SOURCE - MFI0 (MODBUS FLOAT IN - WORD 0)	58
FIG. 172 MAPPING DISPLAY/MAPPING THE SOURCE TO THE DESTINATION	58
FIG. 173 MAPPING DISPLAY/HFO - FLOAT VARIABLES/ENTERING A VALUE FOR WORD 0	58
FIG. 174 HARDY MODBUS-LINK DISPLAY/SELECTING DISPLAY/FLOAT INVERSE	58
FIG. 175 HARDY MODBUS-LINK DISPLAY/555.0000 APPEARS	59
FIG. 176 HARDY MODBUS-LINK DISPLAY/SELECTING BUTTON 23 - READ/WRITE MULTIPLE REGISTERS	59
FIG. 177 HARDY MODBUS-LINK DISPLAY/WRITER MULTIPLE REGISTERS DISPLAY	59
FIG. 178 HARDY MODBUS-LINK/ENTER VALUE DISPLAY	59
FIG. 179 HARDY MODBUS-LINK/ENTER VALUE DISPLAY/ENTERING 999	59
FIG. 180 HARDY MODBUS-LINK/WRITE MULTIPLE REGISTERS/SENDING NEW VALUE	60
FIG. 181 RESPONSE OK POP UP	60
FIG. 182 MAPPING DISPLAY WITH VALUE "999.0000" RECEIVED FROM THE HARDY MODBUS-LINK CLIENT	60
FIG. 183 OPC HETEROGENEOUS COMPUTING ENVIRONMENT	61
FIG. 184 OPC CLIENT/SERVER/ITEMS	61
FIG. 185 OMNISERVER CONFIGURATION DIALOG BOX	61
FIG. 186 OMNISERVER CONFIGURATION DIALOG BOX	62
FIG. 187 WINSOCKET DEVICE CONFIGURATION/DEFAULT PARAMETERS	62
FIG. 188 WINSOCKET CONFIGURATION/ENTERING HI 3000 SETUP PARAMETERS	62
FIG. 189 PINGING HI 3000 MODULE/CONNECTION INDICATED	62
FIG. 190 HI 3000 DEVICE ICON WITH IP ADDRESS	63
FIG. 191 PROTOCOLS DIALOG BOX	63
FIG. 192 PROTOCOL DEFINITION/DOUBLE OR RIGHT CLICK ON	

PROTOCOL SETTINGS - - - - - 63

FIG. 193 PROTOCOLS DEFINITION DIALOG BOX/CREATING PROTOCOL NAME AND DESCRIPTION - - - - - 63

FIG. 194 PROTOCOL DEFINITION/BINARY FORMATS PAGE - - - - - 64

FIG. 195 PROTOCOLS DEFINITION - - - - - 64

FIG. 196 PROTOCOL SETTINGS WITH NEW PROTOCOL DEFINITIONS - - 64

FIG. 197 SELECTING TOPICS ICON - - - - - 64

FIG. 198 TOPICS PAGE/SELECTING A NEW TOPIC - - - - - 64

FIG. 199 TOPIC DEFINITION DIALOG BOX/CREATING TOPIC DEFINITION 65

FIG. 200 TOPIC DEFINITION/VARIABLES PAGE - - - - - 65

FIG. 201 TOPIC DEFINITION/HARDYFLOAT ICON - - - - - 65

FIG. 202 PROTOCOL PAGE/HIGHLIGHTING HARDYOPC_FLOAT - - - - 66

FIG. 203 PROTOCOL PAGE/SELECTING NEW ITEM - - - - - 66

FIG. 204 ITEM DEFINITION DIALOG BOX - - - - - 66

FIG. 205 ITEM DEFINITION - - - - - 66

FIG. 206 ITEM DEFINITION/ENTERING FO00 - - - - - 66

FIG. 207 ITEM DEFINITION - - - - - 67

FIG. 208 PROTOCOL PAGE/ITEM LIST ENTERED - - - - - 67

FIG. 209 ITEM DEFINITION/SEND DATA TRIGGER - - - - - 67

FIG. 210 ITEM DEFINITION/SEQUENCE NUMBER IN - - - - - 67

FIG. 211 ITEM DEFINITION/SEQUENCE NUMBER OUT - - - - - 68

FIG. 212 PROTOCOL PAGE/SELECTING HOST MESSAGE - - - - - 68

FIG. 213 HOST MESSAGE DEFINITION - - - - - 68

FIG. 214 REQUEST PAGE WITH NO REQUEST MESSAGE - - - - - 69

FIG. 215 SELECTING WWW LINK - - - - - 69

FIG. 216 HI 3000 SUPPORT SITE - - - - - 69

FIG. 217 EPS FILES/SELECTING OPC FLOAT DPD FILE - - - - - 69

FIG. 218 FILE DOWNLOAD DIALOG BOX - - - - - 69

FIG. 219 SAVE AS DIALOG BOX/SELECTING PROGRAM FILES - - - - 70

FIG. 220 PROGRAM FILES/SELECTING DESCARTES OMNISERVER - - - 70

FIG. 221 OMNISERVER FOLDER SAVING DPD FILE - - - - - 70

FIG. 222 HOST MESSAGE - - - - - 70

FIG. 223 CHAINS AND TRIGGERS PAGE - - - - - 71

FIG. 224 PROTOCOL DEFINITION/SELECTING UNSOLICITED MESSAGES - - - - - 71

FIG. 225 UNSOLICITED MESSAGE DEFINITION PAGE - - - - - 71

FIG. 226 UNSOLICITED MESSAGE DEFINITION/NAME AND DESCRIPTION ENTERED - - - - - 71

FIG. 227 UNSOLICITED MESSAGE DEFINITION/RECEIVED PAGE - - - - 72

FIG. 228 UNSOLICITED MESSAGE DEFINITION/RECEIVED MESSAGE - - 72

FIG. 229 WONDERWARE/SELECTING WWCLIENT - - - - - 73

FIG. 230 WONDERWARE/CLOSE THE LOG VIEWER - - - - - 73

FIG. 231 WWCLIENT/SELECTING CREATE CONNECTION - - - - - 73

FIG. 232 CREATE CONNECTION DIALOG BOX - - - - - 73

FIG. 233 CREATE CONNECTION DIALOG BOX - - - - - 73

FIG. 234 IOT CONNECTION - - - - - 73

FIG. 235 ITEM DIALOG BOX - - - - - 74

FIG. 236 WWCLIENT/LIST OF IOT CONNECTIONS - - - - - 74

FIG. 237 WWCLIENT/LIST OF ITEMS (FI00) - - - - - 74

FIG. 238 WONDERWARE/OPENING WINDOWMAKER - - - - - 74

FIG. 239 WINDOWMAKER DIALOG BOX - - - - - 74

FIG. 240 WINDOWMAKER/OPENING A NEW WINDOW - - - - - 74

FIG. 241 WINDOW MAKER/CREATING A NEW WINDOW - - - - - 75

FIG. 242 MACHINE MONITOR WINDOW ENTERING ####.#### - - - - 75

FIG. 243 WINDOWMAKER/SELECTING ANIMATION LINKS - - - - - 75

FIG. 244 WINDOWMAKER/OBJECT TYPE DIALOG BOX - - - - - 75

FIG. 245 WINDOWMAKER/ACCESS NAME DIALOG BOX - - - - - 75

FIG. 246 WINDOWMAKER/ADD ACCESS NAME DIALOG BOX - - - - - 76

FIG. 247 WINDOWMAKER/SELECTING TAGNAME DICTIONARY - - - - - 76

FIG. 248 WINDOWMAKER/CREATING A TAG NAME - - - - - 76

FIG. 249 WINDOWMAKER/SELECT TAG DIALOG BOX/SELECTING IPS - - 76

FIG. 250 NEWLY CREATED WINDOW - - - - - 77

FIG. 251 WINDOWMAKER/SELECTING RUNTIME - - - - - 77

FIG. 252 WINDOWMAKER/RUNTIME VALUE - - - - - 77

FIG. 253 HI 3030 MAIN WEB PAGE/SELECTING CONFIGURATION - - - 77

FIG. 254 CONFIGURATION PAGE/SELECTING HARDY CONTROL LINK - - 77

FIG. 255 HARDY CONTROL-LINK PAGE/SELECTING LISTED
 HI 3000 MODULE IP ADDRESS - - - - - 78

FIG. 256 HARDY CONTROL-LINK PAGE SELECTING NODE 5 - - - - - 78

FIG. 257 SELECTED INSTRUMENT'S IP ADDRESS APPEARS
 IN THE NODE 5 TEXT FIELD - - - - - 78

FIG. 258 SAVING THE NODE ADDRESS ASSIGNMENT - - - - - 78

FIG. 259 OK MESSAGE BOX - - - - - 78

FIG. 260 NODE IP ADDRESS CONFIGURED - - - - - 78

FIG. 261 CONFIGURATION PAGE/SELECTING MAPPING SETUP - - - - 79

FIG. 262 MAPPING SETUP PAGE 1 - - - - - 79

FIG. 263 MAPPING SETUP PAGE 1/SELECTING HARDY
 CONTROL-LINK FLOAT OUT - - - - - 79

FIG. 264 HARDY CONTROL-LINK FLOAT OUT SELECTED/WORD 0 - - - - 79

FIG. 265 HARDY CONTROL-LINK FLOAT OUT/WORD 0 (EFO0) SET
 AS MAPPING DESTINATION - - - - - 80

FIG. 266 MAPPING SETUP 2/SOURCE SELECTION PAGE - - - - - 80

FIG. 267 MAPPING SETUP 2/SELECTING PROCESS
 DATA/GROSS WEIGHT - - - - - 80

FIG. 268 PROCESS DATA/GROSS WEIGHT CHANNEL 1 (HF14) - - - - - 80

FIG. 269 GROSS WEIGHT-CHANNEL 1 ASSIGNED TO HARDY
 CONTROL-LINK FLOAT OUT - - - - - 80

FIG. 270 GROSS WEIGHT ASSIGNED TO HARDY CONTROL-LINK
 FLOAT OUT - - - - - 80

FIG. 271 HARDY CONTROL-LINK FLOAT OUT/WORD 2 - - - - - 80

FIG. 272 HARDY CONTROL-LINK FLOAT OUT/WORD 2 SELECTED
 AS DESTINATION - - - - - 81

FIG. 273 MAPPING PAGE 2 SELECTING NET WEIGHT - - - - - 81

FIG. 274 PROCESS DATA/SELECTING NET WEIGHT/CHANNEL 1 - - - - 81

FIG. 275 CURRENT MAPPINGS/NET WEIGHT/CHANNEL 1 (HF18)
 ASSIGNED TO HARDY CONTROL-LINK FLOAT OUT (EFO2) - - - - - 81

FIG. 276 NET WEIGHT ASSIGNED TO HARDY CONTROL-LINK
 FLOAT OUT - - - - - 81

FIG. 277 HARDY CONTROL-LINK FLOAT OUT/WORD 4 - - - - - 81

FIG. 278 HARDY CONTROL-LINK FLOAT OUT/WORD 4 SELECTED
 AS DESTINATION - - - - - 81

FIG. 279 MAPPING PAGE 2 SELECTING GROSS WEIGHT - - - - - 82

FIG. 280 PROCESS DATA/SELECTING GROSS WEIGHT/CHANNEL 2 - - - 82

FIG. 281 CURRENT MAPPINGS/GROSS WEIGHT/CHANNEL 2 (HF18)
 ASSIGNED TO HARDY CONTROL-LINK FLOAT
 OUT/WORD 4 (EFO4) - - - - - 82

FIG. 282 GROSS WEIGHT ASSIGNED TO HARDY CONTROL-LINK
 FLOAT OUT - - - - - 82

FIG. 283 HARDY CONTROL-LINK FLOAT OUT/WORD 6 - - - - - 82

FIG. 284 HARDY CONTROL-LINK FLOAT OUT/WORD 4
 SELECTED AS DESTINATION - - - - - 82

FIG. 285 MAPPING PAGE 2 SELECTING NET WEIGHT - - - - - 82

FIG. 286 PROCESS DATA/SELECTING NET WEIGHT/CHANNEL 2 - - - - 82

FIG. 287 CURRENT MAPPINGS/GROSS WEIGHT/CHANNEL 2 (HF19)

ASSIGNED TO HARDY CONTROL-LINK FLOAT
 OUT/WORD 4 (EFO4) - - - - - 83
 FIG. 288 GROSS WEIGHT ASSIGNED TO HARDY CONTROL-LINK
 FLOAT OUT - - - - - 83
 FIG. 289 SELECTING AN EXPANDED MAP - - - - - 83
 FIG. 290 EXPANDED MAP DIALOG BOX - - - - - 83
 FIG. 291 I/O CONFIGURATION/ADDING A NEW MODULE - - - - - 84
 FIG. 292 SELECT MODULE TYPE - - - - - 84
 FIG. 293 MODULE PROPERTIES DIALOG BOX - - - - - 84
 FIG. 294 REQUESTED PACKED INTERVAL/SELECTING 50.0
 MILLISECONDS - - - - - 85
 FIG. 295 ETHERNET-MODULE HARDY ADDED TO I/O
 CONFIGURATION LIST - - - - - 85

E-Mail

Configuration and Operation - - - - - 87
 FIG. 296 INSTRUMENT HOME PAGE/SELECTING CONFIGURATION - - - 88
 FIG. 297 CONFIGURATION WEB PAGE/SELECTING E-MAIL - - - - - 88
 FIG. 298 E-MAIL CONFIGURATION WEB PAGE - - - - - 89
 FIG. 299 CONFIGURATION MENU/SELECTING SETUP - - - - - 89
 FIG. 300 SETUP MENU/SELECTING ETHERNET - - - - - 89
 FIG. 301 ETHERNET SUB-MENU - - - - - 89
 FIG. 302 ETHERNET MENU/ENTERING INSTRUMENT IP ADDRESS - - - 90
 FIG. 303 ETHERNET MENU/ENTERING DNS IP ADDRESS - - - - - 90
 FIG. 304 SETTING THE STANDARD 3-MAIL/MAIL SERVER, USER ID,
 RETURN MAIL ADDRESS - - - - - 90
 FIG. 305 SETTING THE STANDARD E-MAIL "MAIL TO" ADDRESSES
 AND SELECTING SETPOINTS - - - - - 90
 FIG. 306 CUSTOM E-MAIL WEB PAGE - - - - - 91
 FIG. 307 E-MAIL TEMPLATE FOR E-MAIL #0 - - - - - 91
 FIG. 308 PARTS OF AN E-MAIL ADDRESS - - - - - 91
 FIG. 309 LIST OF PARAMETER DESCRIPTIONS AND
 HEXADECIMAL NUMBERS - - - - - 92
 FIG. 310 MAP DICTIONARY - - - - - 92
 FIG. 311 EXPANDED VIEW OF ENTERED TOKENS - - - - - 92
 FIG. 312 CONFIGURATION WEB PAGE/SELECTING MAPPING SETUP - - 93
 FIG. 313 MAPPING SETUP1/SENDING CUSTOM E-MAIL - - - - - 93
 FIG. 314 MAPPING SETUP 1/SELECTING SEND EMAIL - - - - - 93
 FIG. 315 ENTERING EMAIL NUMBER - - - - - 93
 FIG. 316 SEND EMAIL #0 ENTERED IN THE EQUATION - - - - - 93
 FIG. 317 MAPPING SETUP 2 PAGE - - - - - 94
 FIG. 318 SELECTING LOCAL INPUTS - - - - - 94
 FIG. 319 SELECTING LOCAL INPUT #1 - - - - - 94
 FIG. 320 EQUATION ENTERED (HO3.0=HI0.0) - - - - - 94
 FIG. 321 E-MAIL MAPPING COMPLETE - - - - - 94
 FIG. 322 TESTING E-MAIL - - - - - 94

Security

Setup - - - - - 97
 FIG. 323 CONFIGURATION MENU/SELECTING SECURITY - - - - - 97
 FIG. 324 SECURITY MENU/SETTING SECURITY MENU - - - - - 97
 FIG. 325 SET SECURITY MENU - - - - - 97
 FIG. 326 SECURITY LEVELS ASSIGNED FOR EACH MENU - - - - - 98
 FIG. 327 HOME PAGE/SELECTING CONFIGURATION - - - - - 98
 FIG. 328 CONFIGURATION PAGE/SELECTING SECURITY - - - - - 98
 FIG. 329 ENTER NETWORK PASSWORD DIALOG BOX - - - - - 98
 FIG. 330 PASSWORD AUTHENTICATION FAILED - - - - - 99
 FIG. 331 CONFIGURATION/SECURITY PAGE - - - - - 99
 FIG. 332 CONFIGURATION - SECURITY PAGE TYPING PASSWORDS - - 99

FIG. 333 CONFIGURATION - SECURITY/SELECTING SECURITY
 LEVEL FOR A MENU - - - - - 99
 FIG. 334 CONFIGURATION - SECURITY/PARAMETERS SET FOR
 SECURITY LEVELS - - - - - 99
 FIG. 335 LOGGING ON/ENTERING USER NAME - - - - - 100
 FIG. 336 LOGGING ON/ENTERING PASSWORD - - - - - 100
 FIG. 337 LOGGING ON/STATUS DISPLAY - SECURITY LEVEL HI - - - - - 100
 FIG. 338 LOG ON/ENTER NETWORK USER ID AND PASSWORD - - - - - 100
 FIG. 339 REMOVING USER NAME - - - - - 100
 FIG. 340 ENTER A "0" - - - - - 101

HI 3001

Master Display - - - - - 103
 FIG. 341 MASTER DISPLAY/FRONT PANEL - - - - - 103
 FIG. 342 HI 3030 BUTTON CONFIGURATION - - - - - 104
 FIG. 343 HI 3010 BUTTON CONFIGURATION - - - - - 104
 FIG. 344 MASTER CONFIGURATION DISPLAY/HARDY 3030
 WEIGHT CONTROLLER AT IP ADDRESS 192.168.110.24 - - - - - 104
 FIG. 345 SUMMARY DISPLAY/HI 3030 WEIGHT CONTROLLER - - - - - 104
 FIG. 346 3000 SERIES DOWNLOAD PAGE - - - - - 104

COMMUNICATIONS: INSTALLATION & OPERATION

Overview

The HI 3000 Series of instruments provide the user total monitoring and instrument control via HI 3000 instruments' built-in and optional connectivity which includes:

- DeviceNet (For Cable Installation See Cabling Section - For Network Configuration See Network Section)
- Hardy Link Ethernet (TCP/IP) (For Cable Installation See Cabling Section - For Network Configuration See Network Section)
- IR Port (Wireless)
- RS-232 Simplex Serial Port
- Remote I/O (For Cable Installation See Cabling Section)
- ControlNet (For Cable Installation See Cabling Section - For Network Configuration See Network Section)
- Profibus I/O (For Cable Installation See Cabling Section - For Network Configuration See Network Section)
- Ethernet/IP (For Cable Installation See Cabling Section - For Network Configuration See Network Section)

Now the user can connect to any of the HI Series 3000 products from anywhere in the world, 365 days a year, 24 hours a day, 7 days a week. Hardy's connectivity puts you in touch with your weigh process or vibration monitor at your convenience no matter where you are or where the instrument is located.

DeviceNet™

DeviceNet is a low-level network designed to connect the Hardy HI 3000 Series Instruments to higher-level controllers such as PCs, PLCs, or embedded controllers. The DeviceNet Network is an open, global industry-standard communication network designed to provide an interface through a single cable from a programmable controller or PC directly to all HI 3000 Series instruments as well as smart devices such as sensors, push buttons, motor starters, simple operator interfaces, drives and other weigh modules. With DeviceNet the user can monitor or control multiple applications from one display and allows 3rd party I/O to be easily added to any system. You no longer have to hard-wire each device to an I/O module or I/O block. The network also provides access to the intelligence present in the instruments for superior diagnostics and troubleshooting to help increase system up time. The DeviceNet network lets you monitor your plant-floor devices from a central location and reconfigure them as your needs change or service them as required. The DeviceNet network's capabilities help reduce integration, and reduce installation and wiring costs.

Hardy Control-Link TCP/IP (Ethernet)

All HI Series 3000 instruments are designed with a selectable 10/100 base T Ethernet connection which links your PC to an embedded web server in the instrument. You can connect to an HI Series 3000 instrument via the Internet, Intranet, Extranet, or VPN (Virtual Private Network). Your computer must have an ethernet card and cable with an RJ45 connector to connect to the HI 3000 Series instrument. Once connected you can transfer data, configure, and control any of the instruments from your web browser from any location in your plant or enterprise. Help wizards are also available to assist when performing setup or troubleshooting of an instrument. In addition the browser connects you to the Hardy web site which connects the user to a full range of customer services and support. File downloads from your control room are a snap. No more hauling devices to download files to the instrument. Should you want to download a file or monitor the instrument from your laptop at the site, simply connect a short cable from the laptop to the Ethernet connection at the rear panel of the instrument to transfer files, monitor or configure the instrument. No matter where you are, if you are connected to our instrument you can operate, configure and troubleshoot any HI 3000 Series Instrument.

NOTE: RSNetWorx™ is a trademark of Rockwell Automation. DeviceNet™ is a trademark of the Open DeviceNet Vendor Association, Inc. Control-Link™ is a trademark of Hardy Instruments Inc.

PRS-232 Simplex Serial Port

NOTE: The RS-232 is a Serial Port for a Printer or Scoreboard.

The HI 3000 Series instruments allow the user to control the instrument using Hardy's DeviceNet™ ControlLink™ Software or RSNetWorx™ which can be purchased from Rockwell Automation.

Communication Option Cards

Remote I/O

Under license from The Allen-Bradley Corporation, Hardy Process Solutions has developed a Remote I/O Interface for the HI 3000 Series products.

Hardy Instruments worked with substantial customer input and Allen-Bradley to identify and design the remote I/O communications network which best matched the needs of system integrators and end users for industrial and process applications. The interface is fast, field proven, requires minimal wiring, requires no special software drivers, and is stan-

standard on many Allen-Bradley programmable controllers. Setting each address and baud rate in the instrument, connecting three wires, and writing some ladder logic is all that is needed to begin communicating weighing parameters to and from an HI 3000 Series controller.

ControlNet

ControlNet enables multiple controllers to control I/O on the same wire and permits multicast of both inputs and peer-to-peer data, reducing traffic on the wire and increasing system performance. (See Fig. 1)

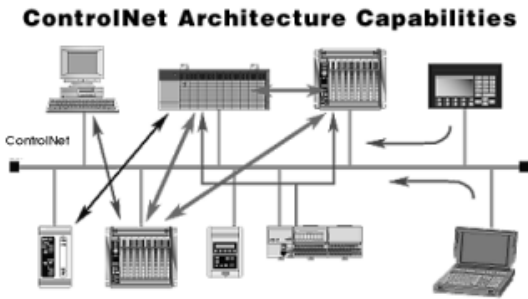

FIG. 1: CONTROLNET ARCHITECTURE

ControlNet is highly deterministic and repeatable. These are important requirements to ensure dependable, synchronized and coordinated real-time performance. Determinism is the ability to reliably predict when data will be delivered, and repeatability ensures that transmit times are constant and unaffected by devices connecting to, or leaving, the network. These capabilities are further enhanced with user selectable I/O and controller interlocking update times to match application requirements.

ControlNet meets the requirements of real-time, high speed applications at the Automation and Control Layer and integrates complex control systems such as batch control systems, weigh process control systems and systems with multiple controllers and human-machine interfaces.

Profibus

The Profibus-DP Communication Profile is designed for efficient data exchange at the field level. The central automation devices, such as PLC/PC or process control systems, communicate through a fast serial connection with distributed field devices such as I/O, drives and valves, as well as measuring transducers. Data exchange with the distributed devices is mainly cyclic. The communication functions required for this are defined by the basic DP functions in accordance with the EN 50 170 standard. In addition to these basic functions, DP also offers extended acyclic communication services for the parameterization, operation, monitoring and alarm handling of intelligent field devices. Loading the

*.GSD file and setting the Node Address and Input and Output Sizes is all you need to begin communicating weighing parameters to and from an HI 3000 Series controller to a PLC, PC or DCS system controller.

MOD-Bus/TPC/IP

TCP/IP is the common transport protocol of the Internet and is actually a set of layered protocols, providing a reliable data transport mechanism between machines. Ethernet has become the de facto standard of corporate enterprise systems and it has also become the de facto standard for factory networking. Ethernet has matured to the point that the cost of implementing this network solution has been dropping to where its cost is commensurate with those of today's field-buses. Using Ethernet TCP/IP in the factory allows true integration with the corporate Intranet and MES systems that support your factory.

Combining a versatile, scaleable, and ubiquitous physical network (Ethernet) with a universal networking standard (TCP/IP) and a vendor-neutral data representation (MOD-BUS[®]) gives a truly open, accessible network for exchange of process data. It is also extremely simple to implement for any device that supports TCP/IP sockets.

Simplicity: MODBUS[®] TCP/IP simply takes the MOD-BUS[®] instruction set and wraps TCP/IP around it. If you already have a MODBUS[®] driver and if you understand Ethernet and TCP/IP sockets, you can in short period of time, have a driver up and running and talking to a PC.

There are no exotic chipsets required to be purchased from vendors, and you can use standard PC Ethernet cards to talk to your implemented device. As the cost of Ethernet falls, you benefit from the price reduction of the hardware, and as the performance improves from 10 to 100 Mbit and soon to 1 Gbit, your technology moves with it protecting your investment.

NOTE: Mod-BUS[®] is a registered trademark of Schneider Automated Inc.

OPC

OLE for Process Control (OPC) enables an HI 3000 module to communicate with any device that supports OLE/COM. The architecture is designed to utilize the Microsoft distributed OLE technology (DCOM) to facilitate clients interfacing to remote servers.

EtherNet/IP™

EtherNet/IP, short for **E**thernet **I**ndustrial **P**rotocol, is an open industrial networking standard that takes advantage of commercial, off-the-shelf Ethernet communication chips and media. Ethernet technology, enables the user to access device-level data from the Internet. The Ethernet/IP networking standard supports both implicit messaging (real-time I/O messaging) and explicit messaging (message exchange). EtherNet/IP is an open network that takes advantage of commercial technology that already exists.

TCP/IP is the transport and network layer protocol of the Internet and is commonly linked with all Ethernet installations and the business world. TCP/IP provides a set of services that any two devices can use to share data. Because Ethernet technology and standard protocol suites such as TCP/IP have been published for public use, standardized software tools and physical media have been mass-produced and are readily available, offering you the benefits of known technology and accessibility. The UDP/IP (User Datagram Protocol) is also used in conjunction with the Ethernet network. UDP/IP provides fast, efficient data transport required for real-time data exchange.

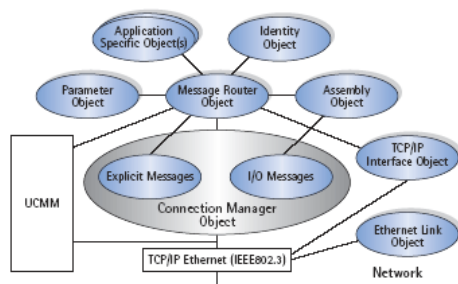

FIG. 2: ETHERNET/IP™ NETWORK

NOTE: *EtherNet/IP™ is a trademark of Rockwell Automation Inc.*

Allen-Bradley Remote I/O

Allen-Bradley License

Under license from The Allen-Bradley Corporation, Hardy has developed a Remote I/O Interface for the HI 3000 Series products.

Hardy Process Solutions worked with substantial customer input and Allen-Bradley to identify and design the remote I/O communications network which best matched the needs of system integrators and end users for industrial and process applications. The interface is fast, field proven, requires minimal wiring, requires no special software drivers, and is standard on many Allen-Bradley programmable controllers. Setting each address and baud rate in the instrument, connecting three wires, and writing some ladder logic is all that

is needed to begin communicating weighing parameters to and from an HI 3000 Series controller.

Each Hardy HI 3000 Series represents a quarter (1/4) rack of discrete I/O (32 bits in the PLC Output and Input image files) to the scanning PLC and supports both discrete and block transfers. The PLC continually exchanges 32 bits of its PLC Input Image Table and 32 bits of its Output Image Table with each 1/4 rack device. In a 1771 I/O Rack, these bits would normally be transferred from and to discrete input and output modules. For the weight controller, the Output Image bits are used to send commands to the weight controller and the Input Image bits return weight data and scale status bits. These actions are referred to as “discrete writes and “discrete reads”. The user is also able to exchange blocks of data with a 1/4, 1/2, 3/4, Full rack device via Block Transfer instructions in the PLC ladder logic program. These commands are referred to as “block writes” and “block reads”.

The host programmable controller can access all configuration and weighing parameters in an HI 3000 Series Instrument, including performing scale calibration. The HI 3000 Series module can be used as a local display and keyboard for weighing parameters, or function as a blind controller properly digitizing the load cell signal and providing responsive setpoint control.

Using the Remote I/O interface shortens development time and provides the most functional weighing interface available for your Allen-Bradley programmable controller. Before starting system design, you should also read the Installation and Operation manual of the HI 3000 Series.

Information contained in this manual is subject to change. Always check the latest version of this manual at our web site (<http://www.hardysolutions.com>) before beginning system design. This product incorporates technology which is licensed by Allen-Bradley Company Inc. Allen-Bradley does not technically approve, warrant or support this product. All warranty and support for this product is provided by Hardy. PLC®, PLC-2®, PLC-3®, PLC-5®, SLC500® Series are registered trademarks of the Allen-Bradley Company, Inc.

Common Applications

The HI 3000 Remote I/O can be used in conjunction with Allen-Bradley programmable controllers to tackle a variety of process control needs. The most basic use of the interface is to simply allow the programmable controller to read weight data from one or more HI 3000 Series weight controllers. In addition to reading weight some other applications are:

- Filling
- Dispensing
- Batch Weighing Control
- Monitoring Rate of Flow

- Evaluating Totalized Weight
- Check Weighing
- Weight Level Alarming
- Condition Monitoring

NOTE: The 3000 Series have 4 mappable outputs in the HI 3010 FillerDispenser and HI 3030 Multi-scale controller and up to seven (7) on some of the other 3000 Series products.

Monitoring Weighing Parameters

The HI 3000 series weight controllers are capable of calculating five types of weight data, including the standard Gross and Net weights. In addition to the standard Gross and Net weights there are three options such as Peak Force, Totalized Weight (block transfer only), and Rate-of-Change or mass flow rate entering or leaving a vessel.

Short Glossary of Terms

1. Gross Weight - is used to describe the total weight of the container and the contents.
2. Net Weight - is the weight of the contents of the container only.
3. Tare Value - The action of adjusting out the known weight of the container from the total indicated weight, so that the indicator reads weight directly.
4. Dead Load - The weight of the vessel and other equipment which will be ignored during zero calibration.

Tare Value

Current Gross Weights become the Tare value by pushing the Tare Push Button on the front panel of the HI 3000 instrument, remote functions contact closure, discrete write or block transfer command by the PLC, or can be entered as a numeric value via the keypad on the front panel of the HI 3000 Series instruments. This new tare value is the reference point for Net Weight.

TV = G - N
 TV = Tare Value (weight)
 G = Gross Weight
 N = Net Weight

Remote I/O Board Cable Termination Dip Switch Configuration

About Cable Termination

HI 3000 Series Remote I/O Modules are connected to a cable in daisy-chain fashion and are referred to as “nodes”. A Daisy Chain is a hardware configuration in which devices

are connected one to another in a series. The first and last Remote I/O module must be terminated.

Step 1. The Terminating Switch is accessible from the rear of the HI 3000 Series Module. (See Fig. 3)

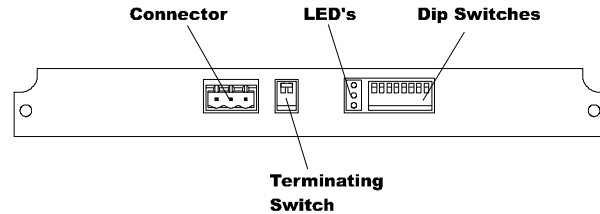

FIG. 3: TERMINATING SWITCH FOR TERMINATING LAST MODULE

Step 2. On the first module and the last module turn the terminating switch to ON.

Step 3. For all other devices on the daisy chain the terminating must be set to OFF.

Dip Switch Settings

Set all the Dip Switch Settings to ON. (See Fig. 3)

Installing the RIO Option Board

CAUTION: MAKE SURE THAT YOU USE AN ANTI-STATIC STRAP WHEN INSTALLING THE REMOTE I/O OPTION CARD.

Step 1. Position the RIO Option Card with the back plane connector facing Option Slot #0. (See Fig. 4)

NOTE: You can only use Option Slot #0 when installing the RIO Option Card.

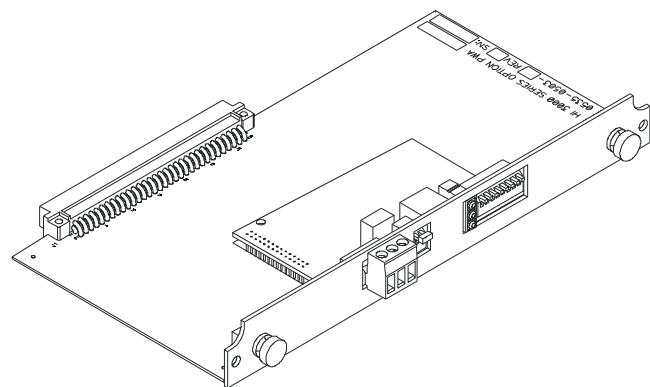

FIG. 4: REMOTE I/O OPTION CARD

Step 2. Slide the RIO Option Card into Slot #0. (See Fig. 5)

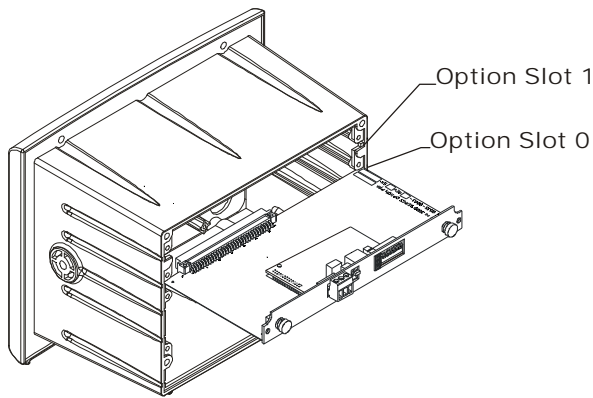

FIG. 5: REMOTE I/O/SLIDE INTO OPTION SLOT #0

- Step 3. Push the Remote I/O card up against the back plane and gently press until the card connector seats in the back plane connector.
- Step 4. Use a phillips head screw driver and install the two (2) screws that fasten the RIO card panel to the HI 3000 Instrument Chassis. (See Fig. 6)
- Step 5. Tighten the screws until the RIO panel is snug. Do not overtighten.

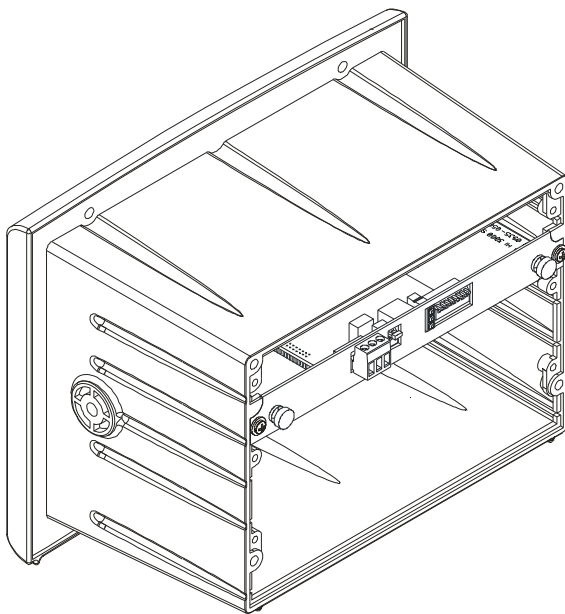

FIG. 6: REMOTE I/O OPTION CARD INSTALLED

- Step 6. Connect the Remote I/O cable to the 3 pin connector on the RIO board.
- Step 7. Connect the other end of the Remote I/O cable to the PLC, SLC or PC Remote I/O Interface card.

Connector Pin Out

Screw Terminal (3-pin)	Description
1	Blue
2	Shield
3	Clear

TABLE 1: SCREW TERMINAL (3-PIN) PIN OUT

LED Indicators

LED	Color	Function
Error (Top LED)	Red	Off: Normal Operation On: Bus off/error
Power (Bottom LED)	Green	Off: Power is Off On: Power is On
Active (Middle LED)	Green	Off: No Communication On: Communication Active

TABLE 2: LED INDICATORS

Removing the Remote I/O Option Card

- Step 1. Disconnect the cables.
- Step 2. Use a phillips head screw driver and remove the two (2) screws that fasten the RIO Option Card panel to the HI 3000 Chassis.
- Step 3. Using the thumb and index finger on both hands, grasp the two (2) knobs on the RIO Card panel and pull away from the instrument.
- Step 4. When the RIO Option Card clears the chassis, store in a static free, safe location.

Remote I/O Configuration Procedures from the Front Panel

- Step 1. At the front panel click on the Setup/3 button. The Configuration Menu appears. (See Fig. 7)

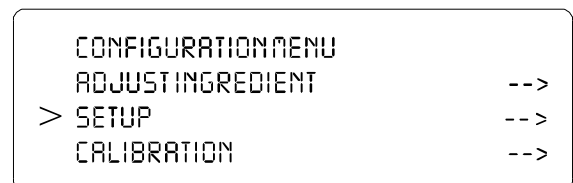

FIG. 7: CONFIGURATION MENU/SELECTING SETUP

Step 2. Push the up or down arrows until the cursor is next to "OPTIONS". (See Fig. 8)

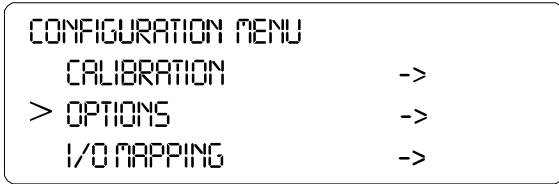

FIG. 8: CONFIGURATION MENU/SELECTING OPTIONS

Step 3. Press the Enter button. The Options submenu appears with Remote I/O selected. (See Fig. 9)
 Step 4. If the cursor is not in front of Remote I/O, push the up arrow until the cursor is aligned with Remote I/O.
 Step 5. Press the Enter button. The Remote I/O Menu appears. (See Fig. 10)

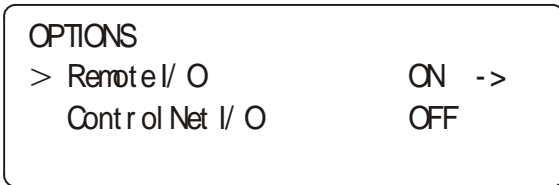

FIG. 9: OPTIONS/SELECTING REMOTE I/O

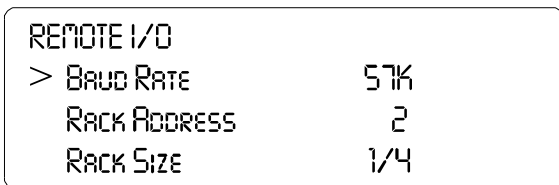

FIG. 10: REMOTE I/O MENU/SETTING PARAMETERS

Step 6. Press the right or left arrow buttons to select the Baud Rate. Left arrow decreases the rate and the right arrow increases the rate. Baud Rate Selections are:

- 57 kbaud
- 115 kbaud
- 230 kbaud.

Step 7. Press the Enter button to save the setting.
 Step 8. Press the down arrow button until the cursor is in front of Rack Address.

- You can set the rack address in one of two ways.
 1. Press on the clear button to clear the existing value then use the alphanumeric keys to enter the address for this module.
 2. Press on the right or left arrow buttons to select the address.
- Address Range - 0-59

Step 9. Press the Enter button to save the setting.
 Step 10. Press the down arrow button until the cursor is in front of Rack Size. (See Fig. 11)

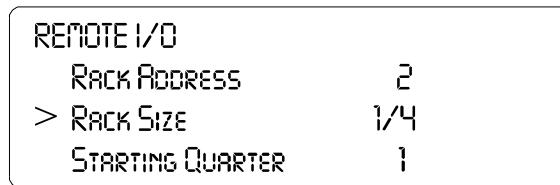

FIG. 11: REMOTE I/O/SETTING RACK SIZE

Step 11. Press the right arrow button to select the rack size of this module. The choices are:

- 1/4 quarter (Can start at 1,2,3,4)*
- 1/2 half (Can start at 1,2,3)*
- 3/4 three quarter (Can start at 1,2)*
- FULL (Can start at 1)*

*NOTE: *The starting points are important when making the starting quarter selection. For example you can have a 1/4 rack start at quarter 1 and a 1/2 rack start at quarter 2.*

Step 12. Press the Enter button to save the setting.
 Step 13. Press the down arrow button until the cursor is in front of Starting Quarter. (See Fig. 12)

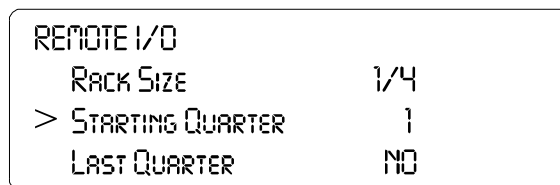

FIG. 12: REMOTE I/O SELECTING STARTING QUARTER

Step 14. Press the right or left arrow buttons to select the starting quarter for this module. Keep in mind the starting quarter requirements due to rack size.

- Step 15. Press the Enter button to save the setting.
 Step 16. Press the down arrow button until the cursor is in front of Last Quarter.
 Step 17. Press the right or left arrow buttons to toggle between NO and YES. If the module is in the last quarter select YES. If the module is not in the last quarter select NO. Make sure you make the correct selection each time.

Remote I/O Configuration Procedures from the Web Page

- Step 1. From the Home Page of the Instrument Click on Configuration. (See Fig. 13) The Configuration Options page appears. (See Fig. 14)



FIG. 13: INSTRUMENT HOME PAGE/SELECTING CONFIGURATION

Configuration - Options

[Smart diagnostic card configuration](#)

[View Remote I/O Configuration](#)

FIG. 14: CONFIGURATION - OPTIONS PAGE/SELECTING VIEW REMOTE I/O CONFIGURATION

- Step 2. Click on View Remote I/O Configuration. (See Fig. 14) The Remote I/O Configuration page appears. (See Fig. 15)

Remote I/O Configuration

Baud:

Address:

Rack Size:

Quarter:

Last Quarter: NO YES



FIG. 15: REMOTE I/O CONFIGURATION PAGE

- Step 3. To select the Baud rate click on the Baud: pull down menu. (See Fig. 16)
- Step 4. Click on the Baud Rate you want to select. Baud Rate Selections are:
- 57 kbaud
 - 115 kbaud
 - 230 kbaud.

NOTE: If you only select one parameter (e.g. Address) you need to click on set configuration to set the entry. You do not need to select every category before setting the configuration.

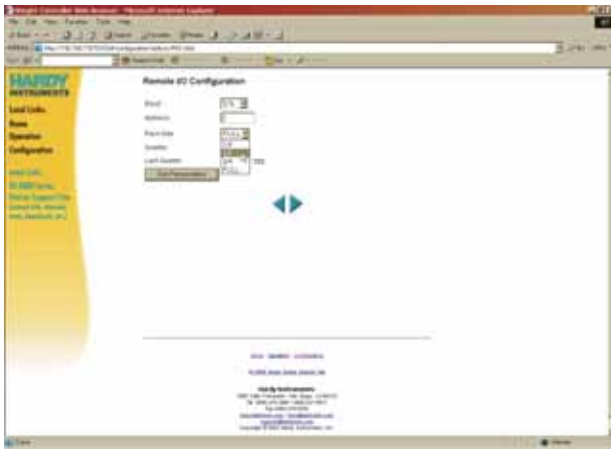

FIG. 16: REMOTE I/O CONFIGURATION/SELECTING BAUD RATE

- Step 5. To set the Node Address double Click in the Address Field. Type in the Node Address of this module.

- Address Range - 0-59

Step 6. To Select the Rack Size, click on the Rack Size pull down menu. (See Fig. 17)



**FIG. 17: REMOTE I/O CONFIGURATION/
SELECTING RACK SIZE**

Step 7. Click on the Rack Size of this module.

The choices are:

- 1/4 quarter (Can start at 1,2,3,4)*
- 1/2 half (Can start at 1,2,3)*
- 3/4 three quarter (Can start at 1,2)*
- FULL (Can start at 1)*

NOTE: **The starting points are important when making the starting quarter selection. For example you can have a 1/4 rack start at quarter 1 and a 1/2 rack start at quarter 2.*

Step 8. To select the Quarter Location, click on the Quarter pull down menu. (See Fig. 18)

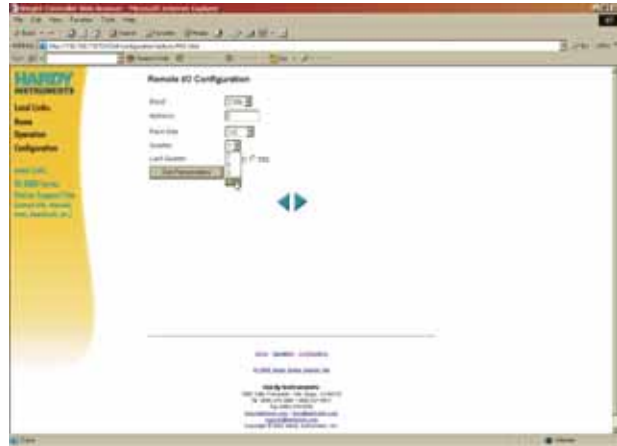

**FIG. 18: REMOTE I/O CONFIGURATION/
SELECTING QUARTER**

Step 9. Click on the Quarter location number of this instrument.

Step 10. You need to determine if this instrument is in the last quarter. If this instrument is not the Last Quarter click in the radio button next to NO (NO is the default selection). If this instrument is the Last Quarter click in the radio button next to YES. (See Fig. 19)



**FIG. 19: REMOTE I/O CONFIGURATION/
SELECTING LAST QUARTER**

Step 11. Click on the Set Parameters button to set the configuration.

Discrete Remote I/O Mapping

NOTE: The input and output tables on the HI 3010 device always start with word 0, regardless of where the words end up in the PLC tables. In the HI 3030 Byte 0 of Word 0 is reserved and cannot be used.

About Discrete Remote I/O Mapping

Discrete Remote I/O Mapping is used when you want to communicate from a 1/4 or 1/2 rack, due to the constraints when getting information in and out of these units.

General Information

- bit: FEDCBA98 76543210
- W0: SWYYYYYY 00000000

S - command-type: 0 = normal 1 = short
 W - R/W action: 0 = read 1 = write
 Y - depends on W

For Reads:

W0: 10AX XNNN 0000 0000	command word (LSB unused)
W1: ---- ---- QQQR RRRR	data word (MSB unused)

A	If A=1, unit acknowledges by copying data byte to bits RO0.8~RO0.15
XX	Reserved. Set to zero.
NNN	Number of words to copy out (0 thru 7)
RRRRR	Index in output scratchpad table of first source word to copy. Scratchpad starts at word 32 of Output Table. Data will be copied, without conversion, to word QQQ and subsequent words
QQQ	Destination word in Output table of first copied word (note that RO1 is first usable full RIO word)

NOTE: If command comes from RI, output will be in RO. If input is DI, output will be in DO.

Read Example: For HI 3010

Read Net Weight into word RSO1 as 16 bit integer in 1/4 rack at address 2, first quarter:

In Mapping write the following:

1. **RSO45=HFI3** (This maps the Net Weight in lbs into a short int at word 13, RO)
2. **CMD0=RSI0** (This indicates there is a command in the RIO in-table word 0.)

PLC puts into the Output file (assuming HI3000 is at 1st 1/4 rack 2):

```

SWA
0:020: 10000001 00000000

                                QQRRRRR
0:021: 000000 00101101

S = 1      A short command
W = 0      A read
A = 0      No ACK
NNN = 1    Read one word
RRRRR = 13 Word Offset 13+32, (i.e. RO45)
QQQ = 1    Copy to RO1 . . .
    
```

This copies one word from word 45 of the RIO out-table to word 1 of the RIO out-table. The data becomes available for RIO discrete PLC reads. Anything that can be mapped can be selected by the command, including remote data. Larger-rack users can specify up to 7 words to read into the discrete I/O area.

For Writes:

W0: 11MNNNNN 00000000	Command Word (LSB unused)
W1: JJJJJJJ JJJJJJJ	First Data Word
(W2: JJJJJJJJJ JJJJJJJJJ)	Second (optional) data word

M	Data Length 0 = 1 word 1 = 2 words (not usable for 1/4 rack)
NNNNN	Index in input scratchpad table of word to change. One or two data words will be copied without conversion. Scratchpad table begins at word 32 of Input Table.

NOTE: There is no command echo for writes.

Write Example 1: For HI 3030

Write 1042 to ingredient 1 Number of Fills:

In Mapping:

User sets: HSO5=RS141 Meaning - Number of Fills = RIO Short Input word 41.
User Writes:CMD0=RSIO Meaning - There is a command at RIO in-table word 0.

PLC puts into its Output file (assuming HI3000 is at 1st ¼ rack 2):

```

SWMNNNNN
O:020: 11001001 00000000

JJJJJJJJ JJJJJJJJ
O:021: 00000100 00010010

S = 1      A short command
W = 1      A Write
M = 0      Write 1 word
NNNNN=(1001)2 Word Offset = 9 (32+9=41)
JJJJJJJJ JJJJJJJJ Value to write 2

```

Write Example 2: For HI 3010

Write 597.1 to ingredient 1 target weight:

In Mapping:

User sets: HFO9=RFI45 Meaning - ingr1 target wt = RIO Float Input word 45.
User Writes:CMD0=RSIO Meaning - There is a command at RSIO in-table word 0.

PLC puts into its Output file (assuming HI3000 is at 1st ¼ rack 2) and 1/2 rack sizes:

```

SWMNNNNN
O:020: 11101101 00000000

JJJJJJJJ JJJJJJJJ
O:021: 01000100 00010101

JJJJJJJJ JJJJJJJJ
O:022: 01000110 01100110

S = 1      A short command
W = 1      A Write
M = 1      Write 2 word
NNNNN=(1101)2 Word Offset - 13(32+13=45)

```

```

J . . = 01000100 00010101
Value to write 0x4415 = MSW of IEEE float 597.1
j . . = 01000110 01100110
Value to write 0x4666 = LSW of IEEE float 597.1

```

Mapping

Mapping is used to:

1. Configure local inputs and outputs of the 3000 Controller using Boolean or non-Boolean statements.
2. Map parameters between Controllers using an Ethernet Network.
3. Map parameters, setpoints, or commands between the local controller and any of the supported communication networks, including ControlNet, Allen-Bradley Remote I/O and DeviceNet.

NOTE: The 3000 Controllers are Masters on DeviceNet, meaning any parameter can be assigned (mapped) to 3rd party I/O on the DeviceNet Network. The Rockwell Automation software package "RSNetwork" is used to assign the I/O on the plant network. HI 3000 Controllers can also be Slave Devices.

Any number of Sources can be mapped to one Destination using the Boolean Statements in the Advanced Mapping Screen.

- Step 1. Select One Destination from the pull down lists in the Local, Network, or Control fields. Once selected, the Destination will automatically fill in on the left-hand side of the equation in the mapping field.
- Step 2. Select one Source in the same manner as in step a. The source can reside in the local controller as a parameter, as a point on one of the network tables, or as a parameter on another 3000 Controller on the Ethernet network. Once selected, the source will automatically fill in on the right-side of the equation in the mapping field.
- Step 3. If more than one source is desired, select one of the Boolean Operators (And, Or, Not), and then repeat step b to select the next source.
- Step 4. To initiate the displayed mapping equation, select the 'Map' key.
- Step 5. To Unmap - or remove a mapping equation - only the destination needs to be selected and the Unmap key pressed.
- Step 6. For more information about Mapping go to the Mapping Chapter for each individual HI 3000 Series product.

CABLING: INSTALLATION

General Introduction to Cabling

This section pertains to unpacking the instrument and installation of the Power, Load Cells, DeviceNet and Ethernet Cables. For more detailed installation information please refer to the HI 3000 Series Service Manual. For specification information please read the HI 3000 Series Service Manual. It is highly recommended that the user follow the installation instructions either implied or explicitly stated in this section to insure the instrument operates as designed.

Unpacking

- Step 1. Before signing the packing slip, inspect the packing for damage of any kind.
- Step 2. Report any damage to the carrier company immediately.
- Step 3. Check to see that everything in the package matches the bill of lading.
- Step 4. If any items are missing, damaged, or you have any questions, please contact Technical Support at:

Hardy Process Solutions.
9440 Carroll park Drive
San Diego, CA 92121

Phone: (858) 278-4900
FAX: (858) 278-6700
Web Site: <http://www.hardysolutions.com>
E-Mail: hardysupport@hardysolutions.com

- Step 5. Record the model number and serial number of the Filler/Dispenser Controller. Store in a convenient, secure location for reference when contacting Hardy Technical Support Department or to buy parts or firmware upgrades.

Input Power Wiring

WARNING: DO NOT OPERATE WITH INCORRECT LINE VOLTAGE. TO DO SO WILL RESULT IN PROPERTY DAMAGE AND/OR PERSONAL INJURY. MAKE SURE THAT THE POWER SOURCE DOES NOT EXCEED 240 VAC.

- The AC power should be supplied by a “clean” primary line, directly from the power panel. This line should not supply any other equipment, including the feeding unit, and should be supplied with a minimum 10 amp breaker. (See Fig. 20)

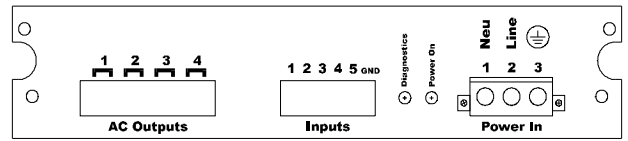

FIG. 20: POWER WIRING DIAGRAM

- Power Input J1

J1-1 Neu (Low)
J1-2 Line (HI)
J1-3 Ground

- Step 1. The HI 3000 Series instruments are configured with a universal power supply rated from 120 to 240 VAC. The instruments can be powered by a 120 or 240 VAC power source and requires no switching or jumper settings.
- Step 2. Install a 3-wire, minimum 14 AWG power line to the 3-pin terminal block connector. (See Fig. 20)
- Step 3. The power and relay circuit card filters and conditions AC power. However, for noisy power lines, external conditioning may be required. For more information, consult the HI 3000 Series Installation and Service Manual or contact Hardy Instruments Technical Support.

Digital Input Wiring

The 5 digital inputs to the HI 3000 series instruments are mappable inputs and are only active when connected to ground. (See Fig. 21)

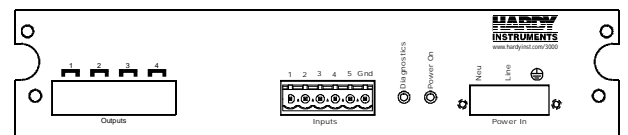

FIG. 21: POWER SUPPLY BOARD REAR PANEL

WARNING: No VOLTAGE EXCEPTED AS AN INPUT DRIVER. DO NOT WIRE 110 VOLTS INTO THE DIGITAL INPUTS. TO DO SO WILL CAUSE PROPERTY DAMAGE AND/OR PERSONAL INJURY.

- Step 1. Connect the input wire to the selected input.
- Step 2. Connect the input wire to some form of dry contact switch. (See Fig. 22)

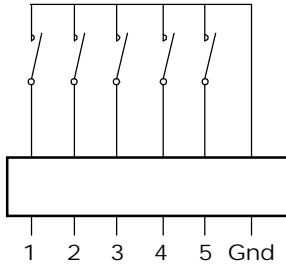

FIG. 22: DRY CONTACT WIRING DIAGRAM

- SIG+ Green
- SEN+ BLUE
- EXC+ RED

Step 3. Go to the product service manuals (Chapter 6) for instructions on how to map to the digital inputs.

Output Relay Wiring

The HI 3000 Series has 4, OPTO22 solid state relays. Please see Relays in Chapter 2 - Specifications of each product Service manual for details.

- Step 1. Wire into the output relay of your choice.
- Step 2. Go to the product service manuals (Chapter 6) for instructions on how to map to the output relays.

Load Point Connections

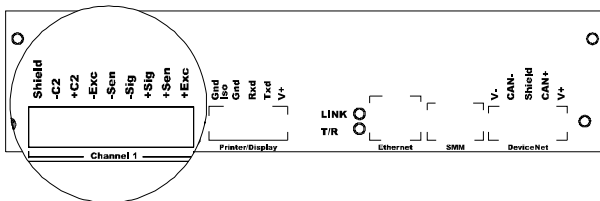

FIG. 23: REAR PANEL/LOAD POINT CONNECTIONS

C2® Load Point Connection

WARNING: LOAD CELL CABLE LENGTH HAS BEEN CALCULATED INTO C2 CALIBRATION DATA. HARDY PROCESS SOLUTIONS RECOMMENDS THAT YOU DO NOT CUT YOUR ADVANTAGE OR ADVANTAGE LITE LOAD SENSOR CABLE, AS YOUR C2 ACCURACY WILL BE AFFECTED AND THE WARRANTY WILL BE VOIDED.

Cable color Code for C2 Load Points (left to right facing the rear panel):

- Shield Ground Wire
- C2- Violet
- C2+ Grey
- EXC- Black
- SEN- Brown
- SIG- White

- Step 1. Remove the factory installed jumper from the terminal block if you are connecting an 8 wire cable from the junction box.
- Step 2. Connect the cable (Recommended load cell cable: Hardy Instruments Prt. # 6020-0001) wires to the Channel 1 terminal block according to the cable color chart.

NOTE: To purchase Hardy Load Cell cable, contact your local Hardy Representative or Distributor.

- Step 3. Plug the terminal block into the Channel connector on the rear panel.
- Step 4. For more information concerning C2 Load Point connections, consult the individual HI 3000 Series Product, Installation and Service Manual.

Non-C2 Load Cell Connection

Cable color Code using Hardy cable from a junction to an instrument - for Non-C2 load cells:

- Shield Ground Wire
- C2- Not Used
- C2+ Not Used
- EXC- Black
- SEN- Brown
- SIG- White
- SIG+ Green
- SEN+ Blue
- EXC+ Red

- Step 1. Remove the factory installed jumper from the terminal block if you have 6 wire load cell cable that includes sense wires from the load cell or junction box.
- Step 2. Connect the cable (Recommended load cell cable: Hardy Prt. # 6020-0001) wires to the J9 terminal block according to the Non-C2 cable color chart.
- Step 3. Plug the terminal block into the Channel 1 (J9) connector on the rear panel.
- Step 4. For more information concerning Non-C2 Load Point connections, consult the HI 3000 Series Installation and Service Manual.

RS 232 Connection

The RS 232 Connection provides for a serial port for transmission to a Printer or a Scoreboard. To configure the Printer or Scoreboard see Chapter 4/Serial Port Parameters in the HI 3030 Service Manual.

NOTE: The HI 3000 instrument transmits data only over a serial connection, it does not receive data.

RS 232 Connection Pinout

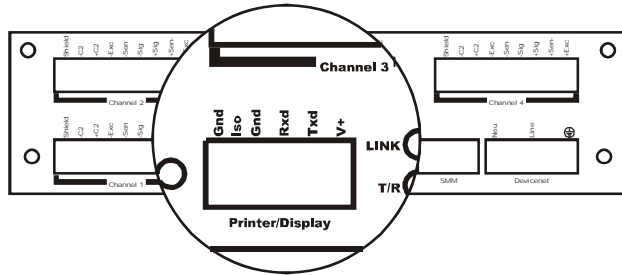

FIG. 24: SERIAL PORT CONNECTION

Reading left to right when viewing the rear panel from the back.

Pin Number	Connection
1	Iso Grnd
2	Grnd
3	Rxd
4	Txd
5	V+ (5VDC)

Table 3: Serial Port Pinout

Hardware Requirements:

Serial Cable with nine pin connector.

-JB Option Wiring

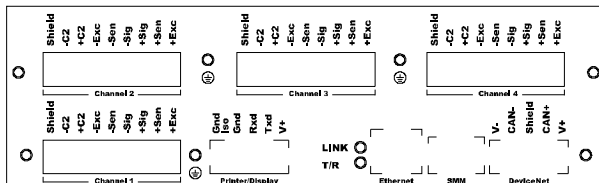

FIG. 25: -JB OPTION CONNECTIONS

- Step 5. Connect the load cell cable wires to the terminal blocks in accordance with the Load Cell manufacturers color code.
- Step 6. Plug the terminal blocks into Channels 1 thru 4 connectors on the rear panel. Write down which load

cell is connected to Channel 1, Channel 2, Channel 3, Channel 4 for future reference.

NOTE: If you have one load point you must plug it into Channel 1. If you have more than one load point you must make sure that you plug one of the load points into Channel 1.

- Step 7. If you only have 3 load cells, do not use Channel 4.
- Step 8. For more information concerning Non-C2 Load Cell connections, consult the HI 3000 Series Service Manual.

Ethernet Cable Connection and Setup

Hardware Requirements:

- Ethernet Card - 10/100 Base T
- Ethernet Cable w/RJ 45 connector.

- Step 1. Plug the RJ45 connector into the Ethernet Connection at the rear panel of the instrument or the Junction Box. (See Fig. 26)

- Plugging the RJ45 connector into an instrument with an HI 3000-RC environmental rear cap does not require removal of the cover. Use needle nose pliers to hold the back of the connector. While holding the connector with the pliers, pass the connector through the access port and press the connector into the RJ45 connector at the rear of the instrument.
- When removing the connector you will need to use a small screw driver and needle nose pliers. While holding the back of the RJ45 connector with the pliers, use the screw driver to push down on the latch at the top of the connector. This releases the connector. Pass the connector back through the access port.

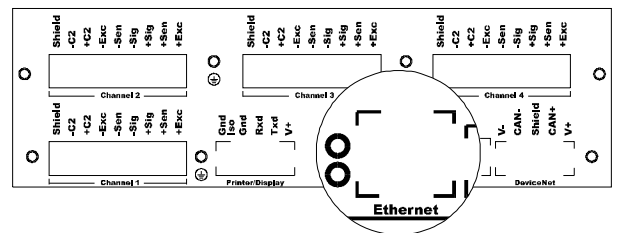

FIG. 26: REAR PANEL/ETHERNET RJ 45 CONNECTION

- Step 2. At the front panel push the Setup button. The Configuration Menu appears. (See Fig. 27)



FIG. 27: CONFIGURATION MENU/SELECTION SETUP

- Step 3. Push the up or down arrows until the cursor is next to “SETUP”. (See Fig. 27)
- Step 4. Press the Enter button. The Setup Submenu appears. (See Fig. 28)

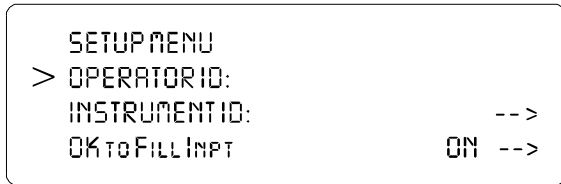

FIG. 28: SETUP MENU

- Step 5. Press the up arrow until the cursor appears in front of Ethernet. (See Fig. 29)

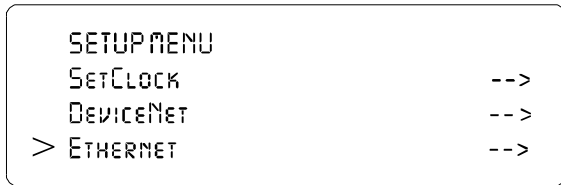

FIG. 29: SETUP MENU/ETHERNET SUB-MENU

- Step 6. Press the Enter button. The Ethernet sub-menu appears. (See Fig. 30)

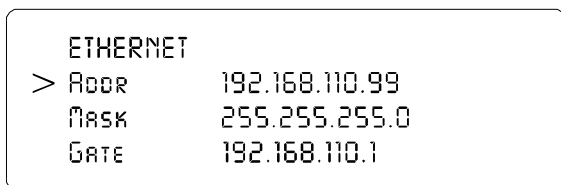

FIG. 30: ETHERNET MENU/DEFAULT IP ADDRESS

- Step 7. The IP address shown in Figure 8 is the default IP address set at the factory. **DO NOT USE THIS ADDRESS.** You must enter a new address. You must do the following:

- Do not repeat any IP addresses used on your network.
- Make sure that you enter integers before the periods between values. Do not leave any periods out of the address.

Bad address: 153.956.124
Correct address: “159.236.456.25”.

NOTE: Check with your network administrator to get the correct IP address for your instrument. IP addresses used in this manual except for the default IP address are for illustration purposes only.

- Step 8. Use the up or down arrows and move the cursor in front of “Addr”. Press the clear button to clear the current or default entry. Use the keypad and enter the new IP address. Be sure and put the periods between the entered values of the address.
- Step 9. When you have entered the IP Address, press the Enter button to set the IP Address in the instrument.
- Step 10. **DO NOT CHANGE THE MASK OR GATE VALUES AT THIS TIME.** For information about configuring the Mask, Gate and DNS, please check with your network administrator or check with Technical Support at Hardy Instruments Inc.
- Step 11. Press the Exit button until you get to the Standby display.
- Step 12. Recycle power to make the IP Address change take effect.
- Step 13. Now that the instrument has a unique IP address you can connect to it from your browser.
- Step 14. Make sure that the ethernet cable is connected to the HI 3000 Series Instrument and to the ethernet card in your computer.
- Step 15. Type in the Instruments IP address in the Address field of your browser. For example: “http://159.236.456.25”. (See Fig. 63) Do not enter the quotation marks. Once the IP address is entered press Enter on your computer keyboard. The System Web page appears and you are ready to use the instrument via the Ethernet. (See Fig. 31)



FIG. 31: ENTER IP ADDRESS IN BROWSER ADDRESS FIELD



FIG. 32: WEB PAGE

Setting the IP Address for the Blind Remote

Since the Blind Remote does not have a keypad you will have to set the IP Address by via the Ethernet (TCP/IP).

Setting or Changing the IP Address using the Ethernet

Software Requirements:

IP Setup

- Step 1. Get the CD ROM that came with HI 3000 Series Instrument and load it into to your CD Drive.
- Step 2. If you don't have the CD or can't find it, you can connect to the HI 3000 Instrument Web Site by opening the Instrument Web page and clicking on the "www.Link: HI 3000 Series Online Support Site" link. (See Fig. 33) Click on Downloads/IP Setup.



FIG. 33: INSTRUMENT WEB PAGE

- On the CD is a folder called Web-Link.
- Open the Folder to get this File - "IPSetup.exe"
- When saving the file from our Web Site, save it to this folder.
- Load "IPSetup.exe" on your hard drive.
- Double click on "IPSetup.exe". The IP Setup Dialog box appears. (See Fig. 34)



FIG. 34: IP SETUP MENU

- Step 3. IP Setup automatically searches the network for all the HI 3000 instrument IP addresses that are on the network. Keep in mind the computer that has the IP Setup application must be connected to the same network as the devices.
- Step 4. In the Select a Unit field, click on the unit IP address that you want to change. You will notice that we clicked on a default address: 192.168.110.99. This means that there is a new HI 3000 Series instrument on the network. The highlighted address also appears in the NDK Settings/IP.
- Step 5. Contact your Network Administrator for the correct IP Address for this unit.
- Step 6. Click in each IP address field that you want to change. **REMEMBER DO NOT DUPLICATE IP ADDRESSES.** Type in the new IP Address. In our example we changed "192.168.110.99" to "192.168.110.52". (See Fig. 35)

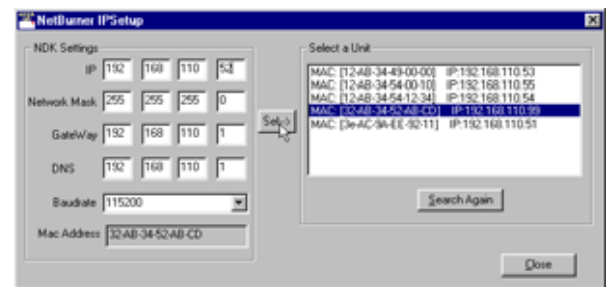

FIG. 35: IP SETUP/SETTING NEW ADDRESS

- Step 7. Click on the Set button. The old address will disappear.
- Step 8. Reset the HI 3000 Instrument by cycling the power off and on.
- Step 9. Press the Search Again button. The new address appears in the Select a Unit field. (See Fig. 36)



FIG. 36: NEW IP ADDRESS IS RESET

Step 10. The IP Address has been reset.

DeviceNet Connection and Setup From the Front Panel

Hardware Requirements:

DeviceNet Cable

Software Requirements:

RSNetWorx™
RSLinx™
Hardy EDS File

NOTE: RSNetWorx™ and RSLinx™ are trademarks of Rockwell Software.

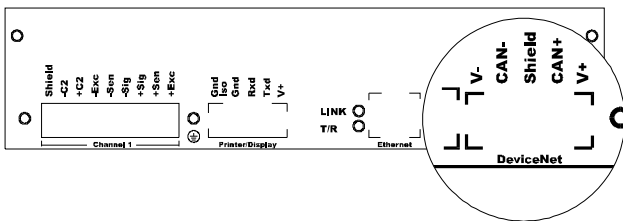

FIG. 37: REAR PANEL/DEVICENET CONNECTION

CAUTION: DO NOT CONNECT V- AND V+ IF YOU HAVE AN EXTERNAL POWER SOURCE ON THE DEVICENET BUS.

Cable color Code for DeviceNet connector:

- V- Black
- CAN- Blue
- Shield Ground Wire

- CAN+ White
- V+ Red

- Step 1. Connect the Cable to the connector using the color code.
- Step 2. Connect the cable connector to the DeviceNet connector at the rear panel. (See Fig. 37)

For HI 3010 Only

- Step 1. At the front panel click on the Setup button. The Configuration Menu appears. (See Fig. 38)

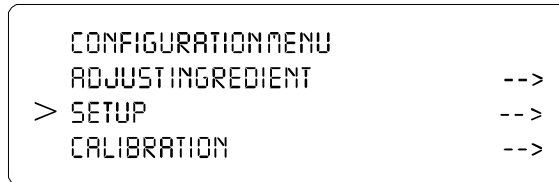

FIG. 38: CONFIGURATION MENU/SELECTING SETUP

- Step 2. Push the up or down arrows until the cursor is next to “SETUP”. (See Fig. 38)
- Step 3. Press the Enter button. The Setup submenu appears.
- Step 4. Press the up or down arrows until the cursor is in front of “Devicenet”. (See Fig. 39)

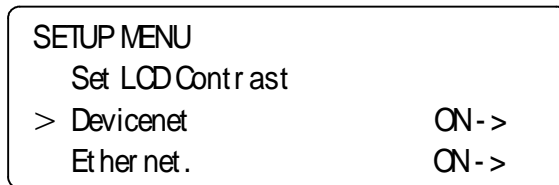

FIG. 39: SETUP MENU/SELECTING DEVICENET

- Step 5. To toggle Devicenet on or off press the right or left arrow buttons. Notice when Devicenet is toggled ON there is an arrow to the right of “ON”. The arrow indicates another sub menu.
- Step 6. Press the Enter button. The Devicenet sub-menu appears. (See Fig. 40)

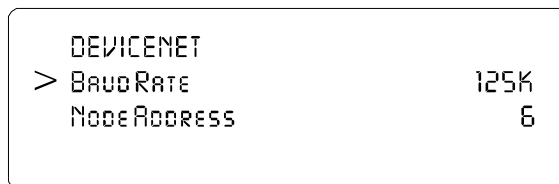

FIG. 40: DEVICENET SUB-MENU/SETTING THE BAUD RATE

- Step 7. Use the up or down arrow to move the cursor in front of “Baud Rate”. (See Fig. 40)
- Step 8. Use the left or right arrows to move through the Baud Rate list. There are 3 baud rates to choose from:

125 K
250K
500K

- Step 9. Once you have made the Baud Rate selection press the Enter button to set the parameter in the instrument.
- Step 10. Use the down arrow to move cursor in front of “Node Address”. (See Fig. 41)
- Step 11. Use the left or right arrows to move the scroll list. Nodes number from 0 to 64.

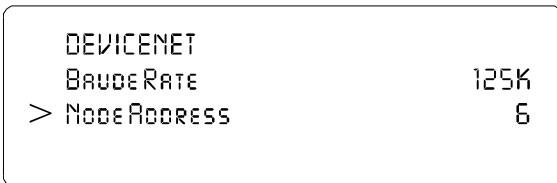

FIG. 41: DEVICENET/SELECTING NODE ADDRESS

- Step 12. When you have selected the correct node number for the HI 3000 instrument, press the Enter button.
- Step 13. Press the Exit button until you are back to the standby display.

For HI 3030, HI 3600, HI 3300

- Step 1. At the front panel click on the Setup button. The Configuration Menu appears. (See Fig. 42)

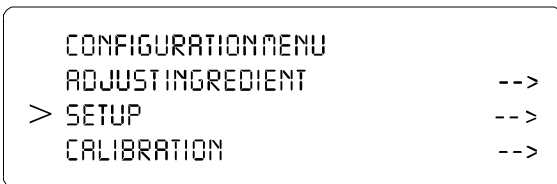

FIG. 42: CONFIGURATION MENU/SELECTING SETUP

- Step 2. Push the up or down arrows until the cursor is next to “OPTION”. (See Fig. 43)
- Step 3. Press the Enter button. The Options sub-menu appears. (See Fig. 44)

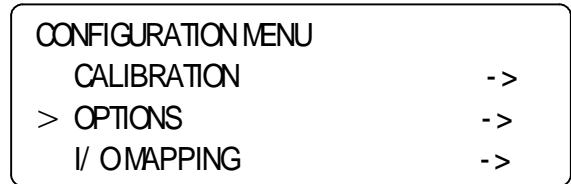

FIG. 43: CONFIGURATION MENU

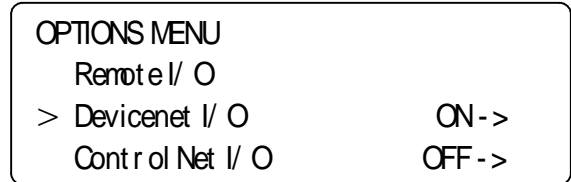

FIG. 44: OPTIONS MENU/SELECTING DEVICENET I/O

- Step 4. To toggle Devicenet on or off press the right or left arrow buttons. Notice when Devicenet is toggled ON there is an arrow to the right of “ON”. The arrow indicates another sub menu.
- Step 5. Press the Enter button. The Devicenet sub-menu appears. (See Fig. 45)

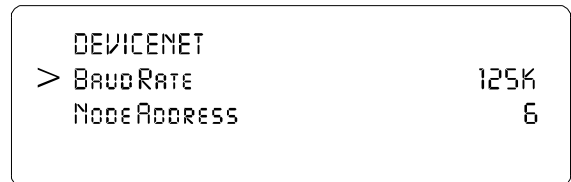

FIG. 45: DEVICENET SUB-MENU/SETTING THE BAUD RATE

- Step 6. Use the up or down arrow to move the cursor in front of “Baud Rate”. (See Fig. 45)
- Step 7. Use the left or right arrows to move through the Baud Rate list. There are 3 baud rates to choose from:

125 K
250K
500K

- Step 8. Once you have made the Baud Rate selection press the Enter button to set the parameter in the instrument.
- Step 9. Use the down arrow to move cursor in front of “Node Address”. (See Fig. 46)
- Step 10. Use the left or right arrows to move the scroll list. Nodes number from 0 to 64.



FIG. 46: DEVICENET/SELECTING NODE ADDRESS

- Step 11. When you have selected the correct node number for the HI 3000 instrument, press the Enter button.
- Step 12. Press the Exit button until you are back to the standby display.

ControlNet Option Card Installation

CAUTION: MAKE SURE THAT YOU USE AN ANTI-STATIC STRAP WHEN INSTALLING THE CONTROLNET OPTION CARD.

- Step 1. Position the ControlNet Option Card with the back plane connector facing Option Slot #0. (See Fig. 47)

NOTE: You can only use Option Slot #0 when installing the ControlNet card.

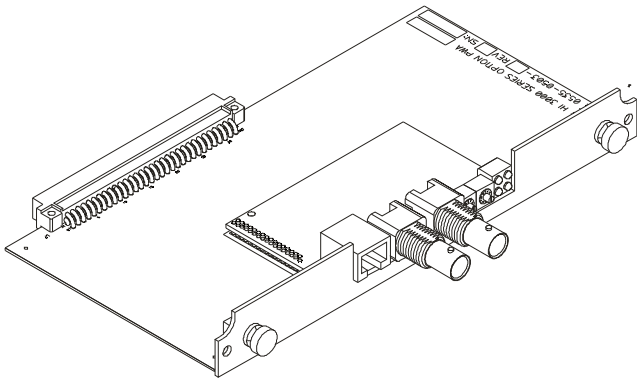

FIG. 47: CONTROLNET/OPTION CARD

- Step 2. Slide the ControlNet Option Card into Slot #0. (See Fig. 48)

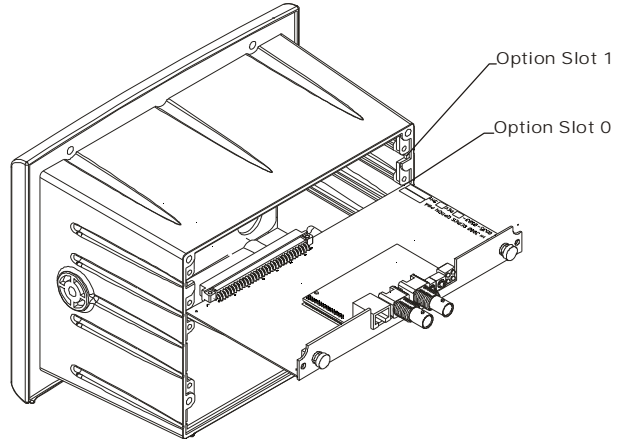

FIG. 48: CONTROLNET/SLIDE INTO OPTION SLOT #0

- Step 3. Push the ControlNet card up against the back plane and gently press until the card connector seats in the back plane connector.
- Step 4. Use a phillips head screw driver and install the two (2) screws that fasten the ControlNet card panel to the HI 3000 Instrument Chassis. (See Fig. 49)
- Step 5. Tighten the screws until the ControlNet panel is snug. Do not overtighten.
- Step 6. Connect the BNC ControlNet cables to the BNC connectors on the ControlNet Option Card.

NOTE: When installing the ControlNet Option Card with the HI 3000-RC (NEMA 4X rear cover) you must use a 90° elbow connector on the ControlNet cable to clear the rear cover.

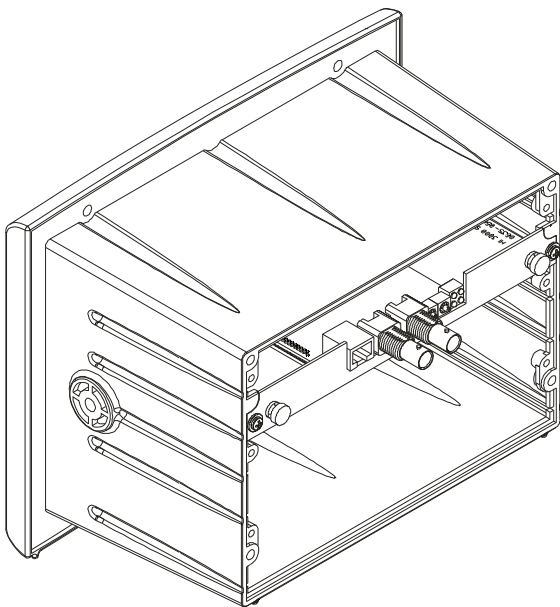

FIG. 49: CONTROLNET OPTION CARD INSTALLED

Removing the ControlNet Option Card

- Step 1. Disconnect the BNC connectors or RS-45 connector.
- Step 2. Use a phillips head screw driver and remove the two (2) screws that fasten the ControlNet Option Card panel to the HI 3000 Chassis.
- Step 3. Using the thumb and index finger on both hands, grasp the two (2) knobs on the card panel and pull away from the instrument.
- Step 4. When the ControlNet Option Card clears the chassis, store in a static free, safe location.

ControlNet Connection and Setup

Hardware Requirements:

- Hardy ControlNet Card.
- ControlNet Cable with BNC Connectors on both ends.

Software Requirements:

- RSNetWorx™
- RSLinx™
- Hardy EDS File (Available on the HI 3000 CD or current EDS file can be downloaded from Hardy Website.)

NOTE: RSNetWorx™ and RSLinx™ are trademarks of Rockwell Software.

Four versions of Network Taps provide flexible mounting options: "Y", "T", straight or 90° elbow (right angled).



FIG. 50: CONTROLNET CABLE ASSEMBLIES

- Step 1. For normal operation connect the Cable to either one of the BNC Connectors on the HI 3000 ControlNet Card located at the rear panel of the HI 3000 Series module. (See Fig. 52)

NOTE: Changing the rotary switches to an address other than 0, 0 - ControlNet will not work. (See Fig. 51)

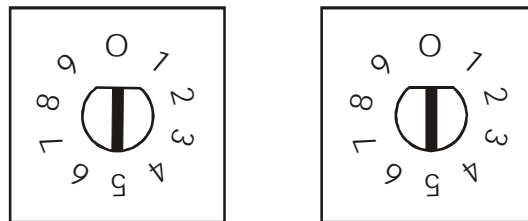

FIG. 51: ROTARY SWITCHES/SETTING NODE ADDRESS TO 0, 0

- Step 2. For redundant operation you need to connect to both BNC connectors.

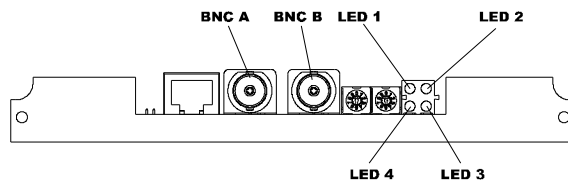

FIG. 52: REAR PANEL CONTROLNET CONNECTORS AND LEDES

Step 3. Connect the cable connector to the BNC connector on the ControlNet Module or the BNC connector on the ControlNet Interface card in your PC.

Setting the ControlNet Node Address from the Front Panel

Step 1. At the front panel click on the Setup/3 button. The Configuration Menu appears. (See Fig. 53)

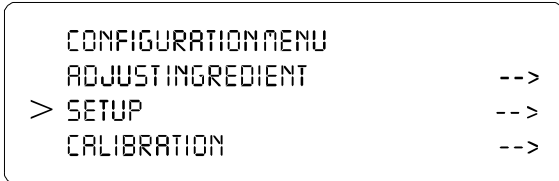

FIG. 53: CONFIGURATION MENU/SELECTING SETUP

Step 2. Push the up or down arrows until the cursor is next to "OPTIONS". (See Fig. 54)

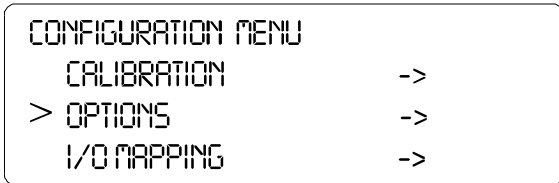

FIG. 54: CONFIGURATION MENU/SELECTING OPTIONS

- Step 3. Press the Enter button. The Options submenu appears. (See Fig. 55)
- Step 4. If the cursor is not in front of "ControlNet I/O", push the down arrow until the cursor is aligned with ControlNet I/O.
- Step 5. Press the Enter button. The ControlNet I/O Menu appears. (See Fig. 56)



FIG. 55: OPTIONS/SELECTING CONTROLNET I/O

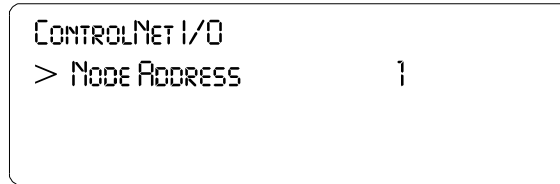

FIG. 56: CONTROLNET I/O MENU/SETTING NODE ADDRESS

- Step 6. Press the right or left arrow buttons to select the Node Address. Left arrow decreases the number and the right arrow increases the number. Nodes number from 1-99.
- Step 7. Press the Enter button to save the setting.
- Step 8. Press the Exit button until you are back to the Main Menu.

Activating ControlNet and Setting the ControlNet Node Address from the Web Page

Step 1. From the Home Page click on Configuration. (See Fig. 57) The Configuration page appears. (See Fig. 58)



FIG. 57: HOME PAGE/SELECTING CONFIGURATION

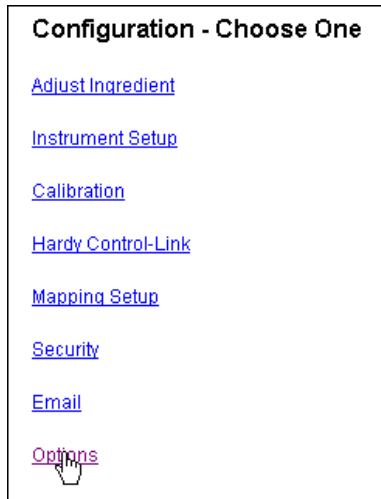

FIG. 58: CONFIGURATION PAGE/SELECTING OPTIONS

Step 2. Click on Options. The Options page appears. (See Fig. 59)

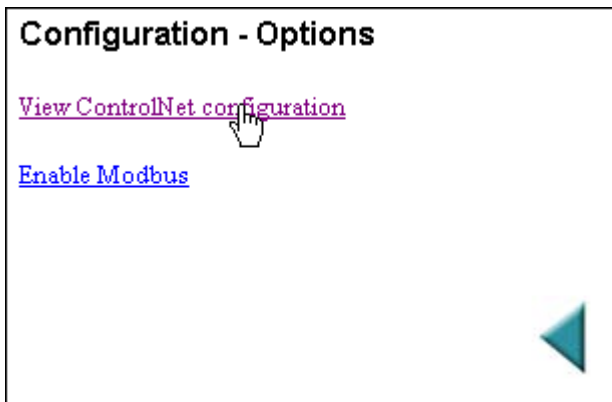

FIG. 59: OPTIONS PAGE/SELECTING VIEW CONTROLNET CONFIGURATION

Step 3. Click on View ControlNet Configuration. The ControlNet Configuration page appears. (See Fig. 60)

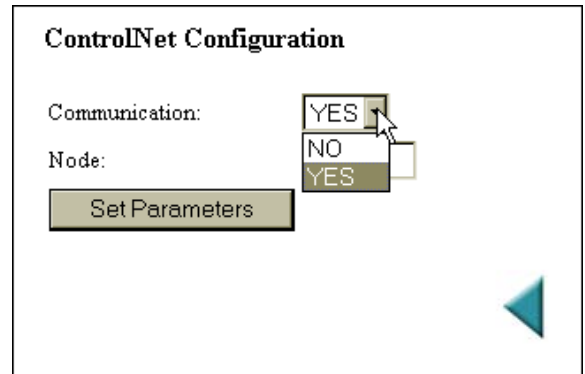

FIG. 60: CONTROLNET PAGE/ACTIVATING CONTROLNET

Step 4. Click on the Communication pull down menu.
Step 5. To activate communications click on YES. To deactivate communications click on NO. Since you want to activate communications, click on YES.

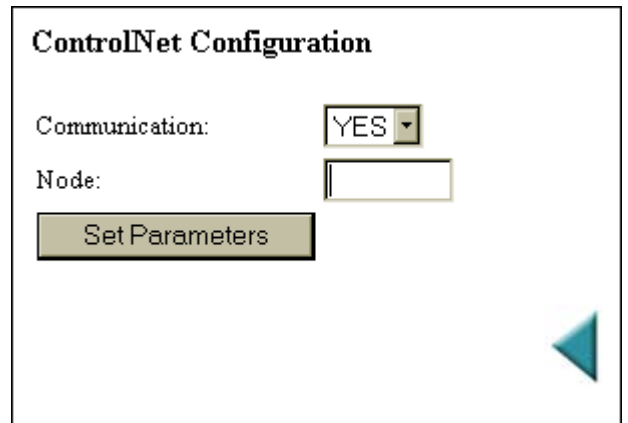

FIG. 61: CONTROLNET CONFIGURATION PAGE/ ENTERING NODE ADDRESS

Step 6. Click in the Node text field. (See Fig. 61)
Step 7. Type in the Node address for the instrument you are configuring. In our example we used Node Address #2. (See Fig. 62)

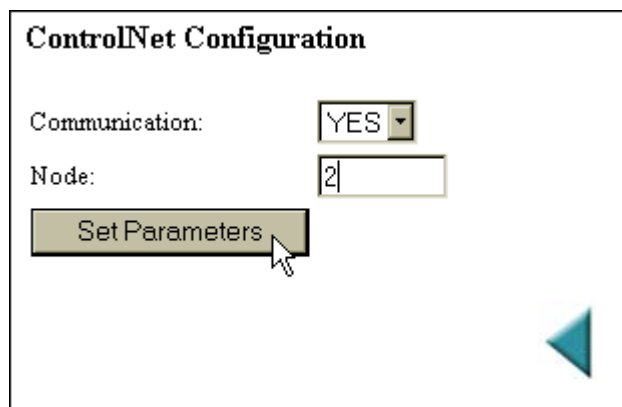

FIG. 62: CONTROLNET CONFIGURATION/ENTERING NODE ADDRESS

- Step 8. Click on the Set Parameters button to save the settings.
- Step 9. Click on the left arrow or the word “home” at the bottom of the page to return to the Home Page.

LED Status Indicators

The ControlNet Card is fitted with four bi-color status and indicator LED’s. (See Fig. 88) During startup the Module Status (LED 1) and the Module Owned (LED 4) are red for one (1) second to indicate they are working properly. After the one second period they are lit as specified below in the tables. After the module is initialized, the network LED’s will flash red/green for one (1) second, indicating a self test of the network chip.

Color	Frequency	Description
Green	Flashing	Module is waiting for initialisation
Green	Steady on	Module is initialized
Red	Flashing	Minor fault, MacID has been changed after initialisation, etc.
Red	Steady on	Major fault, module must be restarted

TABLE 4: LED 1 - MODULE STATUS

Color	Frequency	Description
Red/Green	-	See Table 5

TABLE 5: LED 2 - LED CHANNEL A

Color	Frequency	Description
Red/Green	-	See Table 5

TABLE 6: LED 3 - LED CHANNEL B

Color	Frequency	Description
Green	Steady on	A connection is opened against the ControlNet Module
Off	-	No connection is opened

TABLE 7: LED 4 - MODULE OWNED

Channel LED’s	Description
A & B, steady off	Module is not initialized
A & B, steady red	Faulted unit, must be restarted or repaired
A & B, alternating red/green	Selftest of bus controller
A&B, flashing red	Incorrect node configuration, duplicate MacID, etc.
A or B, steady off	Channel is disabled, depending on network configuration
A or B, steady green	Normal operation of channel
A or B, flashing green	Temporary errors (node will self correct) or node is not configured to go online
A or B, flashing red	Media fault or no other nodes on the network
A or B, flashing red/green	Incorrect network configuration

TABLE 8: CHANNEL LED’S

For information on setting up the module using RSLogix 5000 and RSNetworkx go to the Network Section of this manual.

EtherNet/IP™ Option Card Installation

CAUTION: MAKE SURE THAT YOU USE AN ANTI-STATIC STRAP WHEN INSTALLING THE ETHERNET/IP OPTION CARD.

NOTE: The dip switches do not function. It is a good idea to leave all of them in the OFF position. Should you accidentally turn on a dip switch nothing will happen. The IP address is configured by the firm-

ware which overwrites any and all dip switch settings.

- Step 1. Position the EtherNet/IP Option Card with the back plane connector facing Option Slot #0 or Option Slot #1. (See Fig. 63)

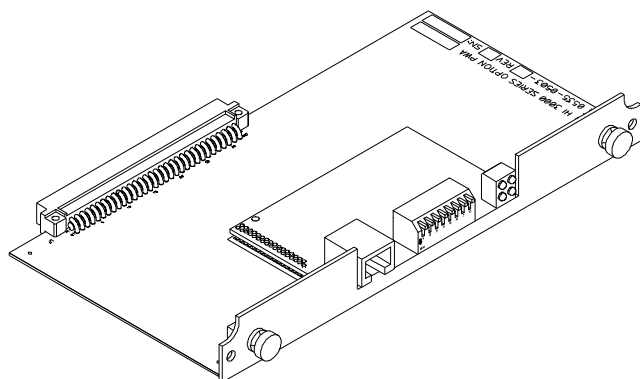

FIG. 63: ETHERNET I/P/OPTION CARD

- Step 2. Slide the EtherNet/IP Option Card into Slot #0. (See Fig. 64)

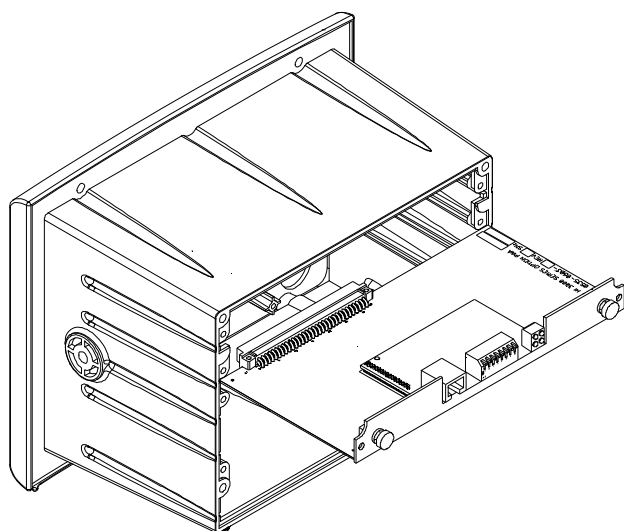

FIG. 64: ETHERNET I/P/SLIDE INTO OPTION SLOT #0

- Step 3. Push the EtherNet/IP card up against the back plane and gently press until the card connector seats in the back plane connector.
- Step 4. Use a phillips head screw driver and install the two (2) screws that fasten the EtherNet/IP card panel to the HI 3000 Instrument Chassis. (See Fig. 65)

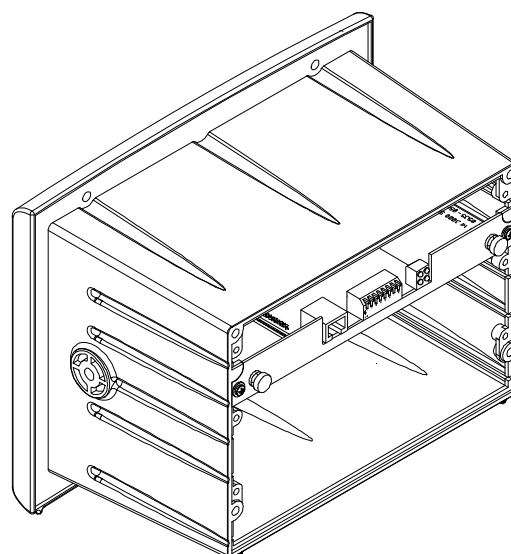

FIG. 65: ETHERNET/IP OPTION CARD INSTALLED

- Step 5. Tighten the screws until the EtherNet I/P panel is snug. Do not overtighten. Recommended 10 inch/lbs torque.
- Step 6. Connect an approved EtherNet/IP (shielded, double shielded, waterproof, etc.) cable to the EtherNet I/P RJ 45 connector on the EtherNet I/P Option Card.

NOTE: Do not use standard ethernet cable that you can buy from a local computer store.

Removing the EtherNet/IP Option Card

- Step 1. Disconnect the EtherNet/IP RJ-45 connectors.
- Step 2. Use a phillips head screw driver and remove the two (2) screws that fasten the EtherNet/IP Option Card panel to the HI 3000 Chassis.
- Step 3. Using the thumb and index finger on both hands, grasp the two (2) knobs on the card panel and pull away from the instrument.
- Step 4. When the EtherNet/IP Option Card clears the chassis, store in a static free, safe location.

Setting Up the EtherNet I/P Address from the Front Panel

- Step 1. At the front panel click on the Setup/3 button. The Configuration Menu appears.
- Step 2. Push the up or down arrows until the cursor is next to "OPTIONS". (See Fig. 66)

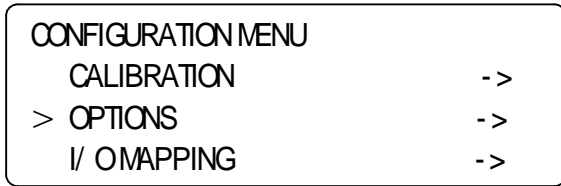

FIG. 66: CONFIGURATION MENU/SELECTING OPTIONS

- Step 3. Press the Enter button. The Options submenu appears. (See Fig. 67)
- Step 4. If the cursor is not in front of Ethernet/IP I/O, push the down arrow until the cursor is aligned with Ethernet/IP I/O.
- Step 5. Press the Enter button. The EtherNet/IP I/O Menu appears. (See Fig. 68)

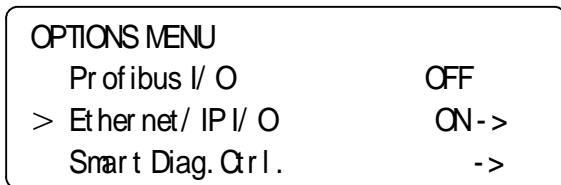

FIG. 67: OPTIONS/SELECTING ETHERNET/IP I/O

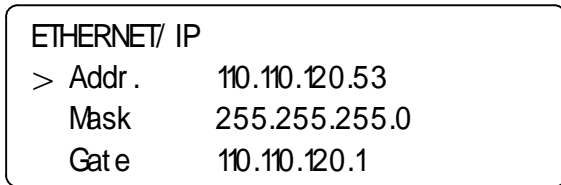

FIG. 68: ETHERNET/IP MENU/SETTING IP ADDRESS

- Step 6. Press the right or left arrow buttons until the cursor is in front of Addr. (See Fig. 68)
- Step 7. Use the alphanumeric keypad to enter the EtherNet/IP Internet Protocol address.

NOTE: This address is different from the HI 3000 Series IP address.

- Step 8. Press the Enter button to save the setting.
- Step 9. Press the right or left arrow buttons until the cursor is in front of Mask.
- Step 10. Use the alphanumeric keypad to enter the EtherNet/IP Mask address. You normally should not have to change this address, however, the mask address sometimes can be different than the default Mask address. Be sure to contact your Network Adminis-

trator before changing the Mask address for the correct Mask Address.

- Step 11. Press the Enter button to save the setting if you changed the setting.
- Step 12. Press the right or left arrow buttons until the cursor is in front of Gate.
- Step 13. Use the alphanumeric keypad to enter the EtherNet/IP Gate address. You normally should not have to change this address, however, the gate address sometimes can be different than the default Gate address. Be sure to contact your Network Administrator, before changing the Gate address, for the correct Gate Address.
- Step 14. Press the Enter button to save the setting if you changed the setting.
- Step 15. Press the Exit button until you are back to the Main Menu.

Setting Up the EtherNet I/P Address from the Web Page

- Step 1. Connect to the HI 3000 by using the IP address for the instrument. (See Fig. 69)



FIG. 69: HI 3000 HOME PAGE/SELECTING CONFIGURATION

- Step 2. Click on Configuration. The Configuration page appears. (See Fig. 70)
- Step 3. Click on Options. The Options page appears. (See Fig. 71)

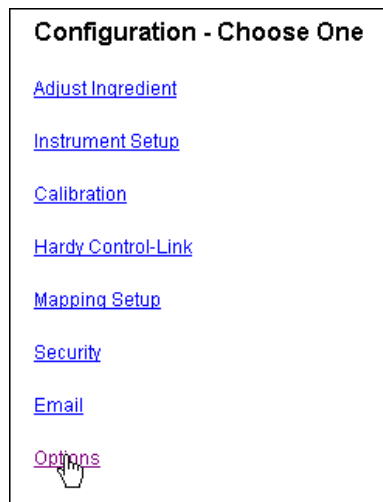

FIG. 70: CONFIGURATION PAGE/SELECTING OPTIONS

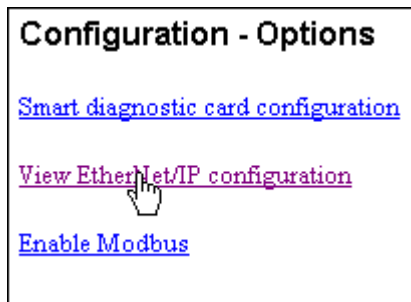

FIG. 71: OPTIONS PAGE/SELECTING VIEW ETHERNET/IP CONFIGURATION

Step 4. Click on View EtherNet/IP configuration. (See Fig. 113) The EtherNet/IP page appears. (See Fig. 72)

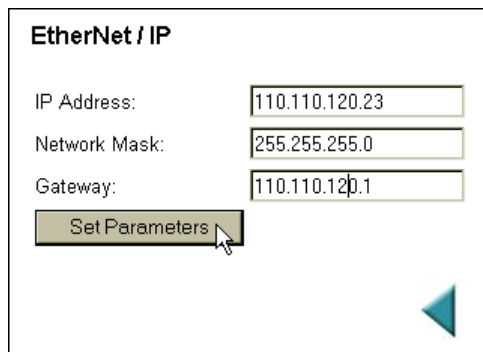

FIG. 72: ETHERNET/IP PAGE/SETTING IP ADDRESS

Step 5. Click in the IP Address text field. Delete the current IP Address.

- Step 6. Type in the new IP address.
- Step 7. If necessary repeat steps 6 & 7 for the Network Mask and Gateway.
- Step 8. Click on the Set Parameters button to save the parameters.
- Step 9. Click on the left arrow or the word “home” at the bottom of the page to return to the Home Page.

LED Status Indicators

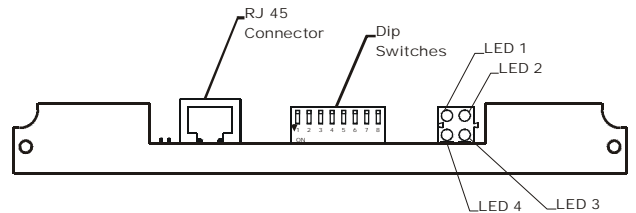

FIG. 73: CONNECTOR/DIP SWITCHES/LEDS

The Ethernet/IP Card is fitted with four bi-color status and indicator LED’s. (See Fig. 115) During startup the Module Status (LED 2) and Network Status (LED 3) are red for one (1) second to indicate they are working properly. After the one second period they are lit as specified below in the tables. The HI 3000 Series products use the default settings.

LED 1 - Link (Activity)

- LED 1 Configuration

Color	State	Indicates:
Green	Steady On	Module has a link
Green	Steady Off	Module does not sense a link

TABLE 9: LED 1 - MODULE STATUS/CONFIGURATION

LED 2 - Module Status

- LED 2 Configuration

State	Summary	Description
Steady Off	No Power	No power applied to the module
Steady Green	Device Operational	The module is operating properly
Flashing Green	Standby	The module has not been configured
Flashing Red	Minor Fault	A minor recoverable fault has been detected

TABLE 10: LED 2 CONFIGURATION

State	Summary	Description
Steady Red	Major Fault	A major internal error has been detected
Flashing Green/Red	Self-Test	The module is performing a power on self test

TABLE 10: LED 2 CONFIGURATION

LED 3 - Network Status

- LED 3 Configuration

State	Summary	Description
Steady Off	No Power or no IP address	The module has no power or no IP address has been assigned
Steady Green	Connected	The module has at least on established EtherNet/IP connection
Flashing Green	No Connections	There are no EtherNet/IP connections established to the module
Flashing Red	Connection Time-out	One of more of the connections in which this module is the target has timed out. This state is only left if all timed out connections are re-established or if the module is reset.
Steady Red	Duplicate IP	The module has detected that its IP address is already in use
Flashing Green/Red	Self-Test	The module is performing a power on self test

TABLE 11: LED 3 CONFIGURATION

LED 4 - Activity

- LED 4 Configuration - This LED flashes green each time a packet is received or transmitted.

Profibus Option Card Installation

CAUTION: MAKE SURE THAT YOU USE AN ANTI-STATIC STRAP WHEN INSTALLING THE PROFIBUS OPTION CARD.

Step 1. Position the Profibus Option Card with the back plane connector facing Option Slot #0.

NOTE: You can only use Option Slot #0 when installing the Profibus.

Step 2. Slide the Profibus Option Card into Slot #0.

Step 3. Push the Profibus card up against the back plane and gently press until the card connector seats in the back plane connector.

Step 4. Use a phillips head screw driver and install the two (2) screws that fasten the Profibus card panel to the HI 3000 Instrument Chassis.

Step 5. Tighten the screws until the Profibus panel is snug. Do not overtighten.

Profibus Connection and Setup

Hardware Requirements:

- Hardy Profibus Option Card
- Profibus Cable with DB9 Serial Connectors on both ends. It is recommended that you use a Serial Connector with a slide switch to terminate an instrument that is located at the end of a Fieldbus (Profibus) Network. (See Fig. 74)

NOTE: The Profibus-DP cable must conform to the PROFIBUS-DP EN 50 170 Specification for Cable.

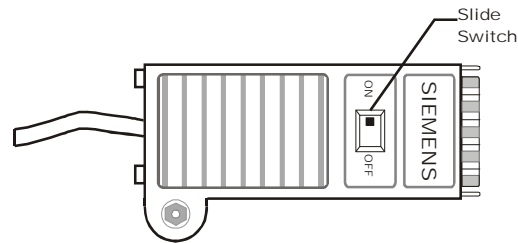

FIG. 74: PROFIBUS DB9 SERIAL CONNECTOR WITH SLIDE SWITCH/MALE

Software Requirements:

- Siemens Step 7™, Simatic Manager or equivalent.
- Hardy *.GSD File (Available on the HI 3000 CD or current.GSD file can be downloaded from the Hardy Website (<http://www.hardyinst.com>) or the Profibus Web Site (<http://www.profibus.com/libraries.html>))

Cabling Guidelines

1. The Trunk Line is the main network cable and anchors the two ends of the network.
2. A Drop Line is the network branch cable between the trunk line tap or junction box and the HI 3000 Series instrument. The baud rate selection can affect and/or restrict each of the following variables:

NOTE: A trade off between the longest length of Trunk and Drop cable that can be used and the selected data transfer speed. Baud rate selection

- The available number of network nodes.
- The total overall length of the Trunk Line.
- The type of cable used for the Trunk Line.
- The sum total length of all individual drop lines.

Cable Specification

The specifications for Profibus standard Type A cable are provided in Table 8. This type of cable is recommended for transmission speeds above 500k baud, and any long distance installations.

Impedance	35 up to 165 ohm at frequencies from 3 to 20 Mhz
Cable Capacity	<30 pF per meter
Cable Diameter	>0.34 mm2, corresponds to AWG 22
Cable Type	Twisted pair cable, 1x2 or 2x2 or 1x4 lines.
Resistance	<110 ohm per km
Signal Attenuation	max 9dB over total length of line section
Shielding	CU shielding braid or shielding braid and shielding foil.
Max Bus Length	200 m at 1500 kbit/second; up to 1.2 km at 93.75 kbit/second. Maximum length may be extended with installation of repeater devices.

TABLE 12:

Step 1. Connect the Profibus cable connectors to the DB9 female serial connector on the Profibus Option Card. (See Fig. 75)

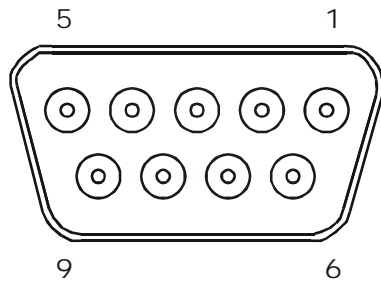

Female Connector on the Hardy Profibus Option Card

FIG. 75: DB9 CONNECTOR ON THE HARDY PROFIBUS OPTION CARD

Pin	Name	Function
Housing	Shield	Connected to PE
1	Not Connected	-
2	Not Connected	-
3	B-Line	Non-inverting RxD/TxD
4	RTS	Request to send
5	GND BUS	GND from RS485
6	+5 V BUS	+5 V from RS485
7	Not Connected	-
8	A-Line	Inverting RxD/TxD
9	Not Connected	-

TABLE 13: 9-PIN DSUB CONNECTOR

Step 2. Use a slotted head screw driver and configure the Node address of the Instrument by setting the flats of the rotary switches so that they are pointing to zero (0,0). (See Fig. 76)

NOTE: Changing the rotary switches to an address other than 0, 0 - Profibus will not work. (See Fig. 76)

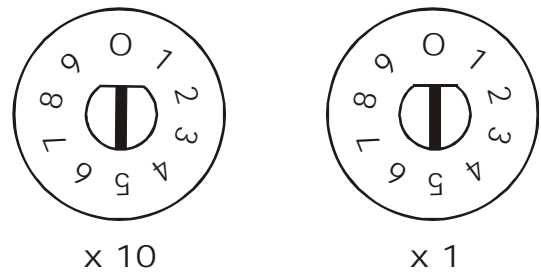

FIG. 76: ROTARY SWITCHES/SETTING NODE ADDRESS TO 0, 0

LED Indicators

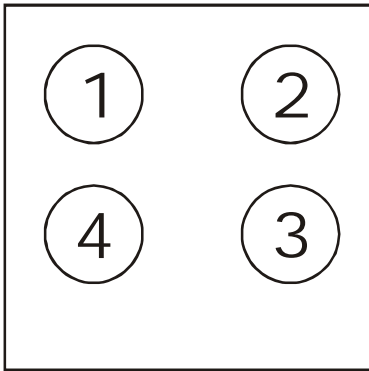

FIG. 77: LED INDICATORS

1. LED #1 - Application Communication Status LED

- Not Used/Always Off

2. LED #2 - Fieldbus On-line

- LED #2 indicates if the module is On-Line or not. If the module is On-Line and data exchange is possible the LED is green.

LED State	Indicates
Off	-Bus is not On-Line -No power to the Module
Green	Bus is On-Line and data exchanges is possible. Fieldbus

TABLE 14: LED #2 - FIELDBUS ON-LINE

3. LED #3 - Fieldbus Off-Line

- The LED indicates that the module is Off-Line and is the opposite of LED #2. If the module is Off-Line and no data exchange is possible, this LED is red, otherwise it is turned off.

LED State	Indicates
Off	-Bus is not Off-Line -No power to the module
Red	Bus is Off-Line, fieldbus running bit cleared in AnyBus status.

TABLE 15: LED #3 - FIELDBUS OFF-LINE

4. LED #4 - Fieldbus Diagnostics

- The LED indicates certain faults on the fieldbus side.

LED State	Indicates
Off	-No diagnostics Present -No power to the module.
Flashing Red 1 Hz	Bus is Off-Line. Fieldbus Config Error running bit set in AnyBus status
Flashing Red 2 Hz	Error in parameter data. Fieldbus Config Error bit set in AnyBus status
Flashing Red 4 Hz	Error in initialization of the Profibus communication ASIC. Fieldbus ASIC Error bit set in AnyBus status

TABLE 16: LED #4 - FIELDBUS DIAGNOSTICS

Removing the Profibus Option Card

- Step 1. Disconnect the DB9 Serial connector.
- Step 2. Use a phillips head screw driver and remove the two (2) screws that fasten the Profibus Option Card panel to the HI 3000 Chassis.
- Step 3. Using the thumb and index finger on both hands, grasp the two (2) knobs on the card panel and pull away from the instrument.
- Step 4. When the Profibus Option Card clears the chassis, store in a static free, safe location.

NOTE: For Configuration instructions see the Network/Profibus I/O section of this manual. The installation for all HI 3000 Series instruments is the same.

Analog Output Option Card Installation

CAUTION: MAKE SURE THAT YOU USE AN ANTI-STATIC STRAP WHEN INSTALLING THE ANALOG OPTION CARD.

- Step 1. Position the Analog Option Card with the back plane connector facing Option Slot #0 or Option Slot #1. (See Fig. 78)

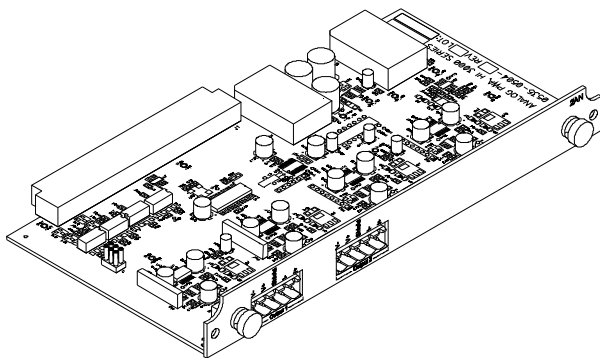

FIG. 78: ANALOG OUTPUT OPTION 2AN

NOTE: You can only use Option Slot #1 if either the RIO Option or the ControlNet Option cards are installed.

Step 2. Slide the Analog Option Card into Slot #0 or Slot #1. (See Fig. 79)

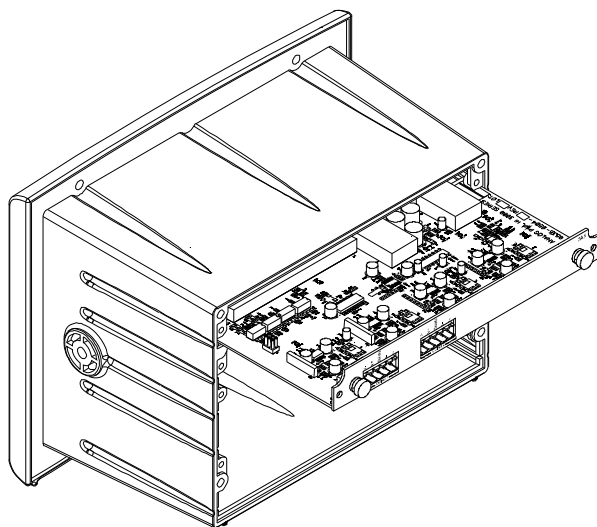

FIG. 79: INSTALLING THE ANALOG OPTION CARD IN A 3000 CHASSIS

- Step 3. Push the Analog card up against the back plane and gently press until the card connector seats in the back plane connector.
- Step 4. Use a phillips head screw driver and install the two (2) screws that fasten the Analog card panel to the HI 3000 Instrument Chassis.
- Step 5. Tighten the screws until the Analog panel is snug. Do not overtighten.

NOTE: If you want 4 Analog outputs, install 2 Analog Output Option cards, one in Option Slot #0 and one in Option Slot #1.

Electrical Connection

Step 1. If you are using a current output (4-20 milliamp) connect the positive and negatives wires to the -I and +I pins. (See Fig. 80)

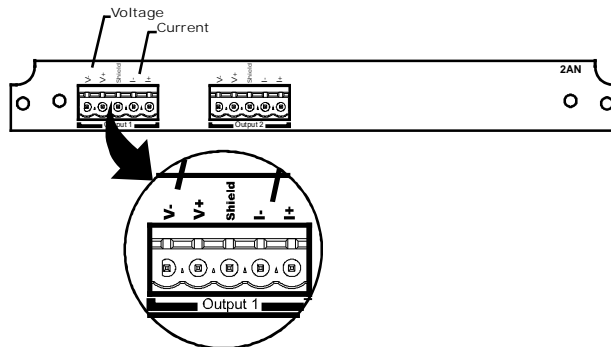

FIG. 80: ANALOG ELECTRICAL CONNECTIONS

- Step 2. If you are using a voltage output (0-10 Volts) connect the positive and negative voltage wires to the (-V and +V pins).
- Step 3. Connect ground to the Shield pin.

CAUTION: DO NOT CONNECT BOTH VOLTAGE AND CURRENT TO ONE OUTPUT CONNECTOR. IF YOU WANT VOLTAGE AND CURRENT OUTPUT IN THE SAME INSTRUMENT YOU MUST WIRE THEM TO SEPARATE OUTPUT CONNECTORS.

Removing the Analog Option Card

- Step 1. Disconnect the connector from the terminal block.
- Step 2. Use a phillips head screw driver and remove the two (2) screws that fasten the Analog Option Card panel to the HI 3000 Chassis.
- Step 3. Using the thumb and index finger on both hands, grasp the two (2) knobs on the card panel and pull away from the instrument.
- Step 4. When the Analog Option Card clears the chassis, store in a static free, safe location.

NOTE: For Configuration and Mapping instructions see the individual HI 3000 product Technical manuals, Configuration Section (Chapter 4). The installation for all HI 3000 Series instruments is the same.

Rear Cover Installation (HI 3000-RC)

Rear cap for the HI 3000 Series controllers. Upgrades the entire assembly to a NEMA 4X rating by enclosing all the rear panel connectors. (See Fig. 123) You will need to install the Cable Grip Assemblies and cabling before installing the Rear Cover.

The HI 3000-RC comes standard with the following parts:

- (1) Rear Cover
- (1) Rear Cap Gasket
- (4) Machine Screws, Panhead, #6-32 x.38L
- (1) NEMA 4, 1" Plug
- (2) Cord Grip, PG-11 THD
- (2) Hex Nuts, PG-11 THD, 26 mm Dia.

NOTE: To purchase additional NEMA 4 plugs, hex nuts and Cord Grips contact your local Hardy Representative.

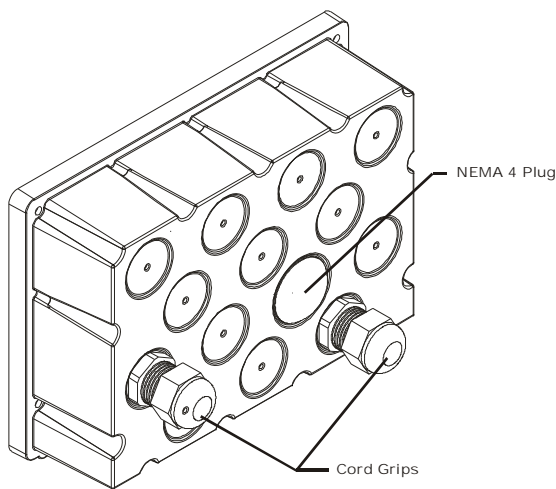

FIG. 81: NEMA 4X REAR COVER

Removing the NEMA 4 Plug

CAUTION: Do NOT USE ANY SHARP OBJECTS WHEN REMOVING OR INSTALLING THE NEMA 4 PLUG. USING SHARP OBJECTS MAY DAMAGE THE PLUG AND MAY DESTROY THE NEMA 4X SEAL.

- Step 1. From the inside of the Rear Cover, using your finger, gently push the middle of the plug toward the rear cover until the plug releases.
- Step 2. Store in a secure location or place in an empty hole to maintain the rear cover NEMA 4 seal.

Installing the NEMA 4 Plug

- Step 1. Place the plug over the hole. (See Fig. 82)
- Step 2. Gently press the NEMA 4 plug toward the rear cover until the plug is snug against the outside surface of the rear cover and snaps into place.

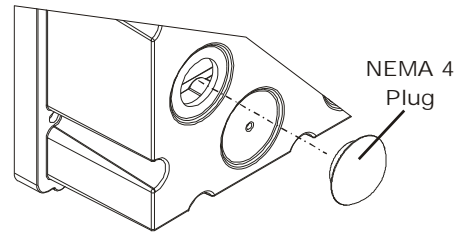

FIG. 82: INSTALLING NEMA 4 PLUG

Installing the Cord Grip Assemblies

Step 1. If you are installing the grips into a pre-existing hole, do the following:

- If there is a NEMA 4 plug installed, remove it. (See "Removing NEMA 4 Plug" above for instructions)
- Slide the Cord Grip Assembly into the hole in the rear cover. (See Fig. 83)

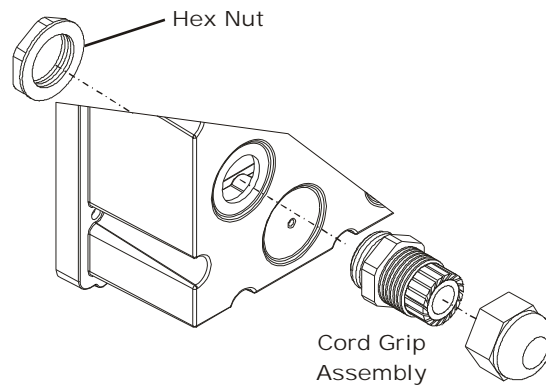

FIG. 83: INSTALLING THE HEX NUT ONTO THE CORD GRIP ASSEMBLY

- Screw the Hex Nut onto the threaded end of the Cord Grip Assembly until it is finger tight and the cord grip assembly is flush against the outside surface of the rear cover. (See Fig. 84)

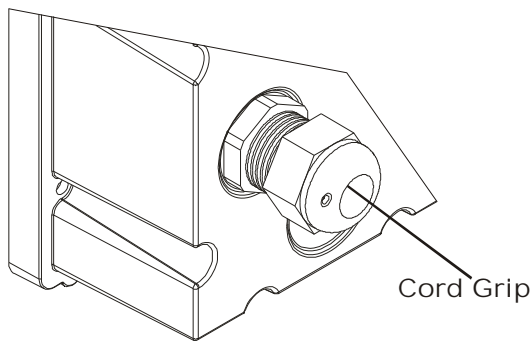

FIG. 84: CORD GRIP INSTALLED

- Use a box end wrench to hold the cord grip assembly nut so that it doesn't move when tightening the Hex Nut.
- Use a box end wrench to tighten the Hex Nut until the Cord Grip assembly is snug against the rear cover. Do not over tighten.

Step 2. If you are installing a Cord Grip Assembly into a location which requires drilling a hole into the rear cover do the following:

- Locate the indent that is closest to the connector you want to connect to.
- A 1" inch diameter hole is required when using Hardy Cord Grip Assemblies.
- Place the rear cover on a secure, flat surface preferably a drill press table.
- Place a wooden block under the location of the hole you want to drill. This will prevent ragged edges from forming when drilling or using a hole saw.

NOTE: When using a hole saw make sure you use a fine tooth hole saw and not the coarse tooth hole saw.

CAUTION: DO NOT USE A HOLE PUNCH. A HOLE PUNCH MAY CRACK THE REAR COVER AND DESTROY THE NEMA 4X SEAL.

- Center the drill bit in the preformed centering indent and drill or saw the hole through the rear cover.
- Use emery cloth and lightly touch up the inside and outside surfaces of the hole to remove any burrs.
- Slide the Cord Grip Assembly into the hole in the rear cover. (See Fig. 85)

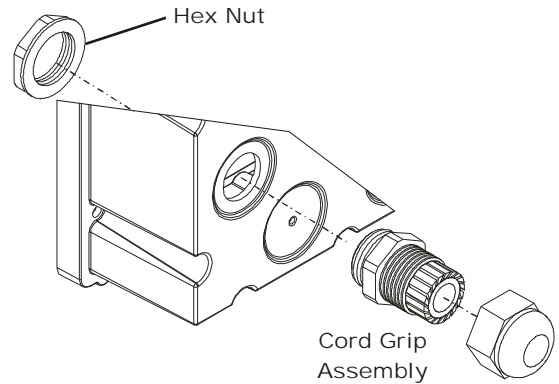

FIG. 85: INSTALLING THE HEX NUT ONTO THE CORD GRIP ASSEMBLY

- Screw the Hex Nut onto the threaded end of the Cord Grip Assembly until it is finger tight and the cord grip assembly is flush against the outside surface of the rear cover. (See Fig. 86)

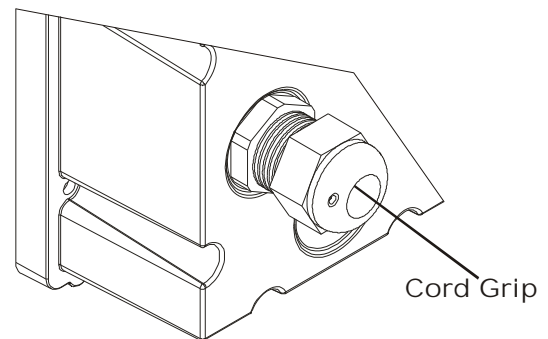

FIG. 86: CORD GRIP INSTALLED

- Use a box end wrench to hold the cord grip assembly nut so that it doesn't move when tightening the Hex Nut.
- Use a box end wrench to tighten the Hex Nut until the Cord Grip assembly is snug against the outside surface of the rear cover.

CAUTION: DO NOT OVER TIGHTEN. OVERTIGHTENING CAN CRACK OR DAMAGE THE REAR COVER.

- Slide the cable through the Cord Grip Assembly. Make sure that you slide enough of the cable so that you can create a cable relief bend and connect to the connectors in the rear panel of the instrument. (See Fig. 87)

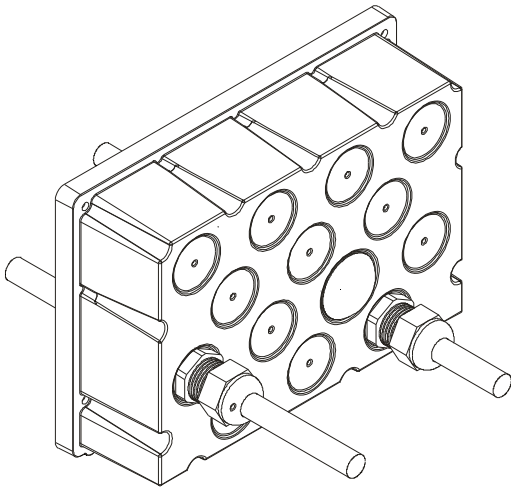

FIG. 87: INSTALLING CABLES IN THE CORD GRIP ASSEMBLY

NOTE: When installing a BNC connector to the Control-Net Option Card you must use a 90° elbow to allow sufficient room to correctly route the cable.

Removing the Cord Grip Assembly

- Use a box end wrench to hold the cord grip assembly nut so that it doesn't move when loosening the Hex Nut.
- Use a box end wrench to remove the Hex Nut.
- Slide the Cord Grip out of the rear cover.
- For further disassembly you can use a box end wrench and remove the Cord Grip Nut, although it is not necessary for removal.
- Install a NEMA 4 plug.

Installing the HI 3000-RC Rear Cover

- Step 1. Check to see that all the Cable Grips and Cables are installed.
- Step 2. Install the wires into the cord grips in the rear panel.
- Step 3. Connect the wires to the connectors on the rear panel of the HI 3000 instrument.
- Step 4. Position the rear cover, pulling the cable if necessary so that the thru holes on the rear cover align with the threaded holes on the HI 3000 Instrument chassis. (See Fig. 88)

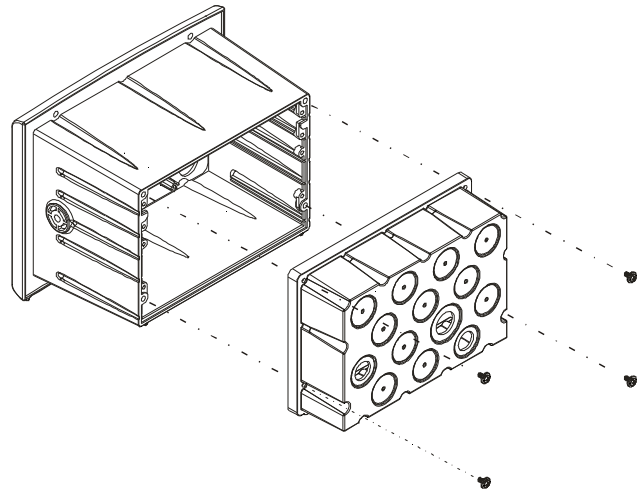

FIG. 88: ALIGNING THE REAR COVER TO THE CHASSIS

- Step 5. Place the rear cover onto the rear of the Chassis.
- Step 6. Use a phillips head screw driver and screw the four (4) screws into the threaded holes on the rear panel of the chassis.
- Step 7. Tighten the screws until they are snug. There is a gasket installed in the rear cover which needs to be slightly depressed to provide a NEMA 4X seal.

CAUTION: Do NOT OVERTIGHTEN. OVERTIGHTENING MAY DAMAGE THE REAR COVER OR THE INSTRUMENT.

- Step 8. Use a box end wrench and tighten the Cord Grip Assembly Nut until the cables when tugged do not come out of the Cord Grip. (See Fig. 89)
- Step 9. Install the NEMA 4 plugs in empty holes if necessary. (See Fig. 89)

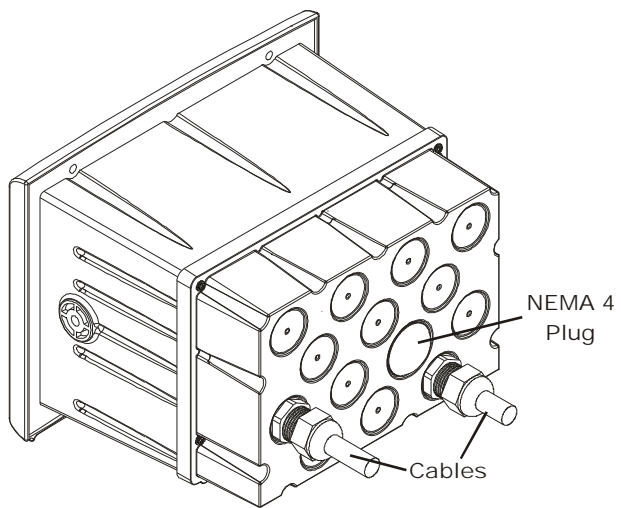

FIG. 89: REAR COVER, NEMA 4 PLUGS, AND CORD GRIPS INSTALLED

NETWORK: INSTALLATION

About Networks

The HI 3000 Series Network configurations include:

- Hardy Control-Link (Ethernet 10/100 Base T)
- DeviceNet
- ControlNet
- Profibus DP
- Ethernet/IP
- Modbus TCP/IP

This enables the HI 3000 Series to communicate with virtually every device on the network, including PCs and PLCs. This means that you can map, configure and monitor all the HI 3000 series products from the front panel or your LAN, Internet, DeviceNet, ControlNet and Wireless Servers that are connected to the Network.

Simple Ethernet Network (See Fig. 90)

Materials Required

- Ethernet Card for your LapTop.
- Ethernet Crossover Cable with RJ45 Connectors on both ends.
- Browser on your Lap Top.



FIG. 90: SIMPLE HARDY CONTROL-LINK NETWORK

Step 1. Contact your Network Administrator for the IP address of the instrument you want to connect to. If the Instrument does not have an IP address, create one. (See Cabling: Installation/Ethernet Cable Connection and Setup Section in this manual)

NOTE: To connect to the HI 3000 instrument requires that your laptop IP address be in the same Class and the same Network Segment. For example if the IP address of the instrument is 192.168.110.x you will have to create an IP address for your laptop that includes the first three octets. An octet

consists of a 3 digit number between 0 and 255. An IP address consists of 4 octets. The first three (3) octets identify the network. The 4th octet is the identifier for the individual node. (See Fig. 91)

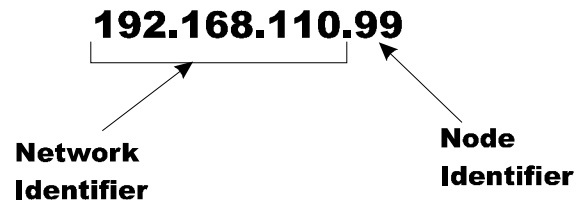

FIG. 91: IP ADDRESS CONFIGURATION

- Step 2. Connect one of the RJ45 Connectors to the Ethernet connection at the rear panel of the HI 3000 Series products.
- Step 3. Connect the other RJ45 Connector to the Ethernet connection on your Laptop Ethernet card or your Ethernet Adapter. The 10BaseT Cable pinouts are as follows:

Pin	Colors on one side of Cable	Colors on other end of Cable
1	Orange/White	Orange/White
2	White/Orange	White/Orange
3	Green/White	Green/White
4	White/Blue	White/Blue
5	Blue/White	Blue/white
6	White/Green	White/Green
7	Brown/White	Brown/white
8	White/Brown	White/Brown

TABLE 17: PINOUTS FOR 10BASE T STANDARD CABLE

Pin	Colors on one side of Cable	Colors on other end of Cable
1	White/Orange	White/Green

TABLE 18: PINOUTS FOR 10BASE T CROSSOVER CABLE

Pin	Colors on one side of Cable	Colors on other end of Cable
2	Orange/White	Green/White
3	White/Green	White/Orange
4	Blue/White	Blue/white
5	White/Blue	White/Blue
6	Green/White	Orange/White
7	White/Brown	White/Brown
8	Brown/White	Brown/White

TABLE 18: PINOUTS FOR 10BASE T CROSSOVER CABLE

- Step 4. Start your computer.
- Step 5. Click on Start.
- Step 6. Click on Settings.
- Step 7. Click on Control panel. The Control Panel appears.
- Step 8. Click on the Network Icon. (See Fig. 92) The Network dialog box appears. (See Fig. 93)



FIG. 92: CONTROL PANEL

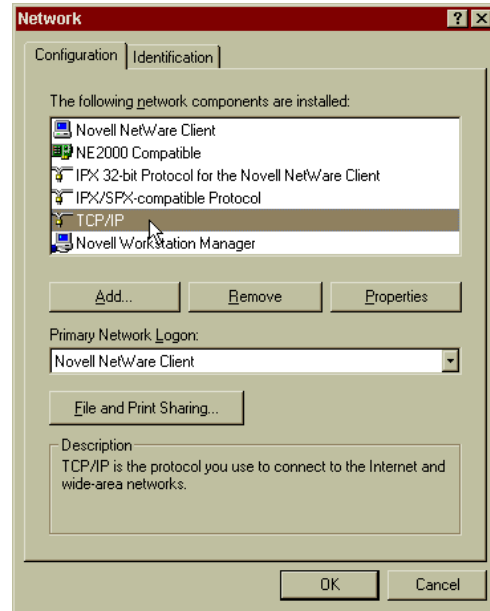

FIG. 93: NETWORK DIALOG BOX/SELECT TCP/IP

- Step 9. Click on the Properties button. (See Fig.94) The TCP/IP dialog box appears. (See Fig. 95)
- Step 10. In the IP address field, type in an IP address. Make sure that the segment (first three octets) are the same as the HI 3000 Instrument you are connected to. For the last octet make sure that the number you enter is not the node address of any other device on the network.

- To get the IP address of the instrument from the front panel, go to the Setup Menu and press the up arrow button until the cursor is in front of Ethernet.
- Press the Enter button. The Ethernet IP Address appears.
- You can also get the IP address from your Network Administrator.

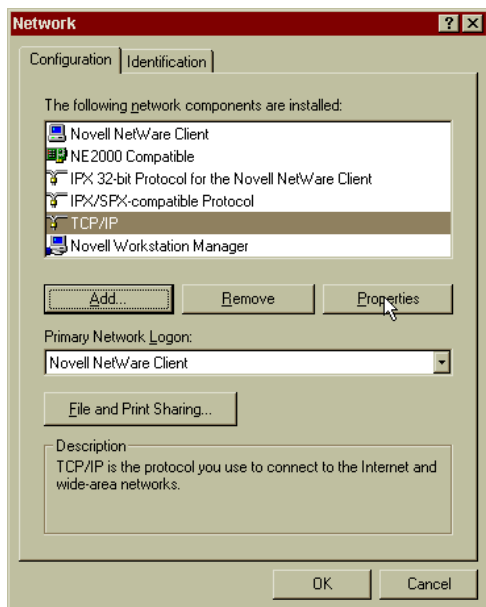

FIG. 94: NETWORK DIALOG BOX/SELECT PROPERTIES

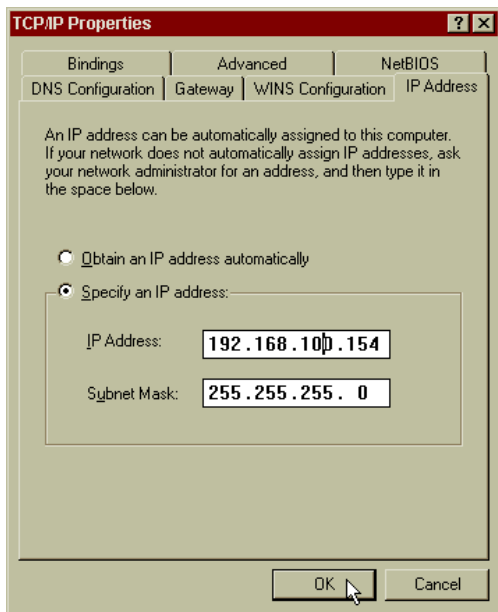

FIG. 95: TCP/IP PROPERTIES/IP ADDRESS

- Step 11. Click on OK.
- Step 12. Open up your browser.
- Step 13. In the Address field in the Browser, type in the IP Address for the instrument you are connected to.
- Step 14. The Product Home Page appears.
- Step 15. If the Product Home Page does not appear.
- Step 16. Click on Start.
- Step 17. Click on Settings.

Step 18. Click on the Internet Options Icon. The Internet Explorer Properties dialog box appears. (See Fig. 96)

Step 19. Make sure that the Never dial a connection is checked.

Step 20. Click on OK.

Step 21. Type in the IP address of the HI 3000 series instrument you are connected to and the Product Home page appears.

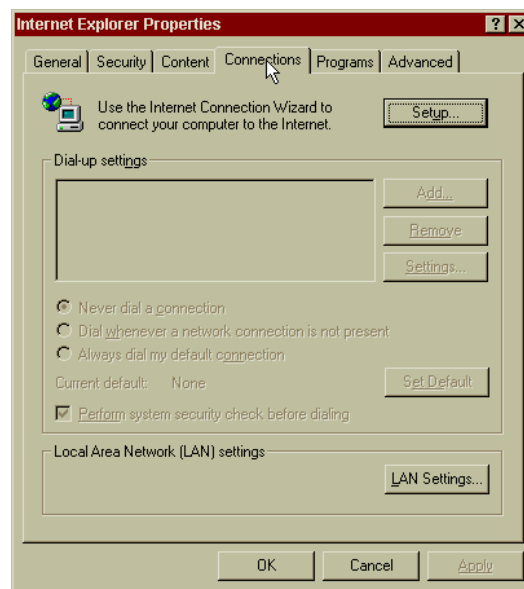

FIG. 96: INTERNET PROPERTIES DIALOG BOX

Hardy Control-Link Ethernet Network

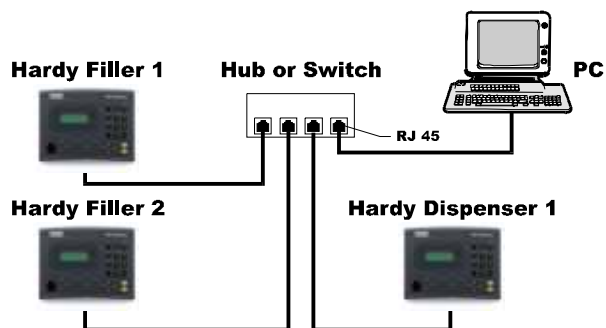

FIG. 97: HARDY CONTROL-LINK ETHERNET NETWORK

Materials Required

- 3, 4, 5, 8 Port Hub (Depends on how many devices you are going to connect to the hub.
- 10/100 Base T Ethernet Card for the PC.

- Ethernet Cables with RJ45 connectors on both ends.

- Step 1. Connect the Standard Ethernet cables between all the HI 3000 instruments and the hub or Switch.
- Step 2. Connect the a Standard Ethernet cable between the PC and the Hub or Switch.
- Step 3. Create an IP address for each of the HI 3000 Series instruments and the PC. (See Cabling: Installation/ Ethernet Cable Connection and Setup Section in this manual). (For the PC see Simple Ethernet Network above.)
- Step 4. Start your computer.
- Step 5. Start the Browser and type the IP address of the instrument you want to monitor or configure.

Setting Node Addresses for HI 3000 Series Instruments from the Browser

- Step 1. From the HI 3000 Series instrument Home Page click on Configuration. (See Fig. 98) The Configuration page appears. (See Fig. 99)

NOTE: We are showing the HI 3010 Filler/Dispenser however all HI 3000 Series instruments are configured the same way.



FIG. 98: FILLER/DISPENSER HOME PAGE/ SELECTING CONFIGURATION

Configuration - Choose One

- [Adjust Ingredient](#)
- [Instrument Setup](#)
- [Calibration](#)
- [Hardy Control-Link](#)
- [Mapping Setup](#)
- [Security](#)
- [Email](#)

FIG. 99: CONFIGURATION PAGE/SELECTING HARDY CONTROL-LINK

- Step 2. Click on “Hardy Control-Link”. The Configuration - Hardy-Link Page appears. (See Fig. 100)

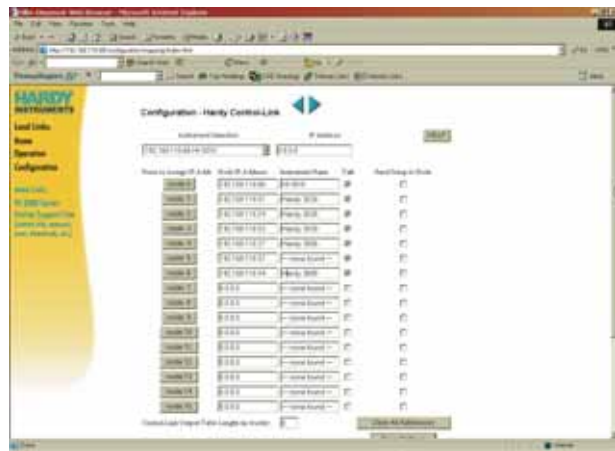

FIG. 100: CONFIGURATION - HARDY CONTROL-LINK PAGE

- Step 3. If other HI 3000 Controllers are attached to the Hardy Control-Link Network, you can view their IP addresses by clicking on the “Instrument Selection” pull down list. All connected devices are listed. (See Fig. 101)

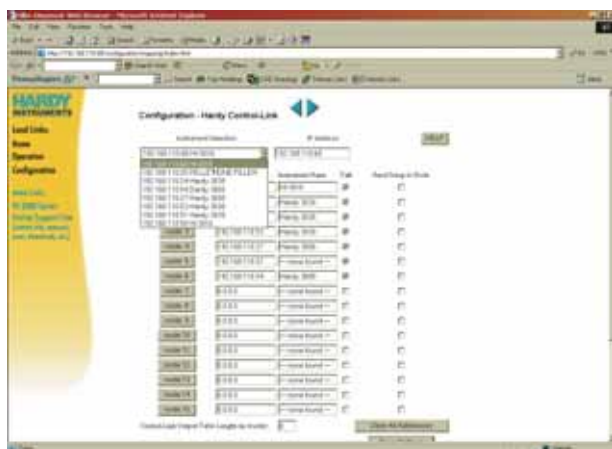

FIG. 101: CONFIGURATION - HARDY CONTROL-LINK/INSTRUMENT SELECTION PULL DOWN LIST

- Step 4. When you arrive at the Configuration - Hardy Control-Link page for the first time the Node address fields have “0.0.0.0” and the Instrument Name fields indicate “none found” however the instrument you are currently using is displayed in the Instrument Selection field. (See Fig. 102)
- Step 5. To Assign an IP address to a node, click on the instrument you want to assign to a node in the pull down list. The IP address of the selected instrument loads into the IP Address field. (See Fig. 103)



FIG. 103: SELECTED INSTRUMENT WITH IP ADDRESS IN IP ADDRESS FIELD

NOTE: It is always a good practice to assign node 0 to the instrument you are currently using.

- Step 6. Click on the node 0 button to assign the HI-3010 to Node 0. The IP address and model of the instrument appear in the Node 0, “Node IP Address”. (See Fig. 104)

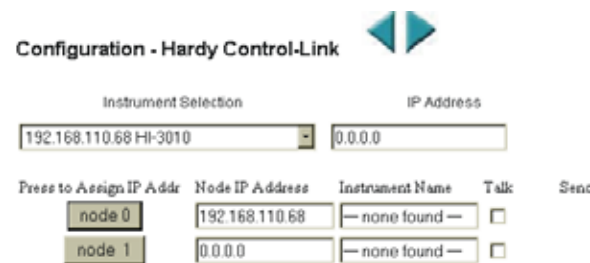

FIG. 104: HI-3010 (IP ADDRESS 192.168.110.68) ASSIGNED TO NODE 0

- Step 7. Repeat Steps 5 and 6 to assign the next instrument to node 1. (See Figs. 105 & 106)

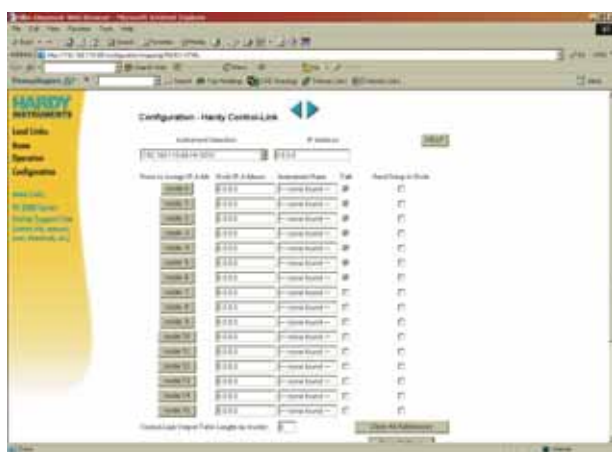

FIG. 102: CONFIGURATION PAGE WITH INSTRUMENTS NOT ASSIGNED A NODE ADDRESS

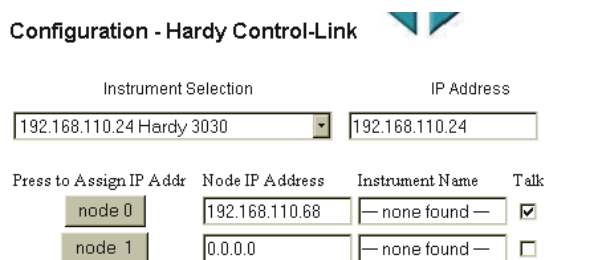

FIG. 105: SELECTED INSTRUMENT WITH IP ADDRESS IN IP ADDRESS FIELD

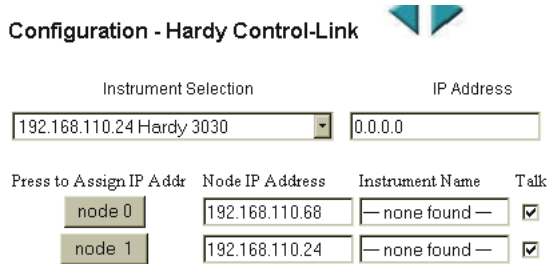

FIG. 106: HI-3010 (IP ADDRESS 192.168.110.24) ASSIGNED TO NODE 1

- Step 8. Continue assigning instruments to the node addresses until all the instruments you want in the table are assigned. (See Fig. 107)
- Step 9. Now click in the Talk check boxes to allow the instruments to communicate with each other. (See Fig. 107)

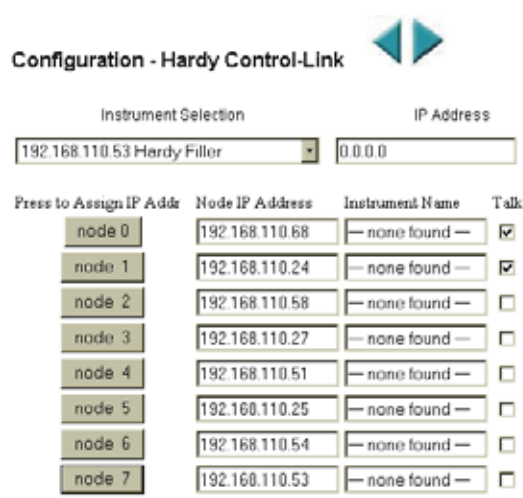

FIG. 107: INSTRUMENTS ASSIGNED TO NODE 0 THROUGH NODE 7

- Step 10. Click on the Save Settings button to save the configuration. (See Fig. 108)

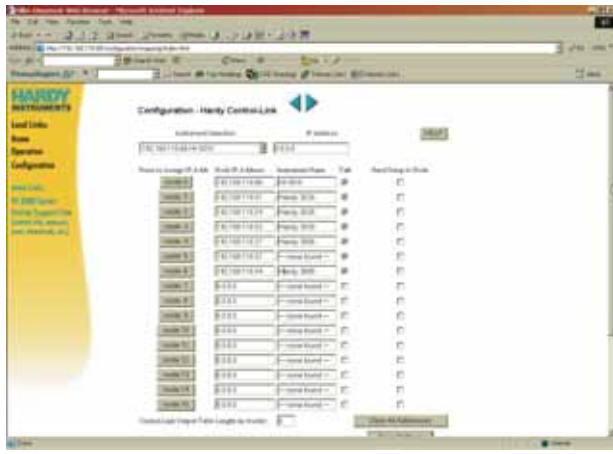

FIG. 108: SAVING THE CONFIGURATION

- Step 11. This is an optional procedure but highly recommended. If you want to transfer an exact copy of the node 0 setup to another node, click in the “Send Setup to Node” check box of the node you want to receive the setup of Node 0. (See Fig. 109) In our example we sent the setup to node 1.
- Step 12. Click on the Save Settings button to complete the transfer.

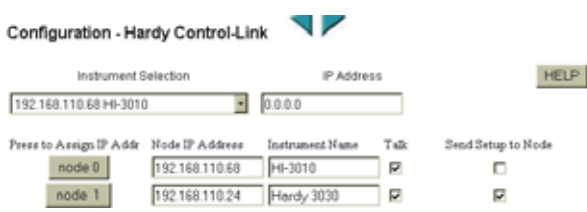

FIG. 109: TRANSFERRING THE NODE CONFIGURATION FROM NODE 0 TO NODE 1

NOTE: It is a good idea to have the same node setup on every HI 3000 Series Instrument on your Hardy Control-Link Network.

Using the Ping Tool

To troubleshoot the network and instrument configuration go to Chapter 7 - Troubleshooting in the HI 3000 Series Instrument Service Manual.

Devicenet Network Setup

RSNetWorx Setup for HI 3000 Series Instruments

- Step 1. Download the Hardy EDS file either from the CD that came with your instrument or go to the Hardy Instruments Website to get the most current file. Put the Hardy EDS file in the Rockwell Software folder. **DO NOT PUT THE EDS FILE IN THE EDS FOLDER!**
- Step 2. Start up RSNetWorx.
- Step 3. Click on the Tools pull down menu. (See Fig. 110)
- Step 4. Click on EDS Wizard. The EDS Wizard dialog box appears. (See Fig. 111)

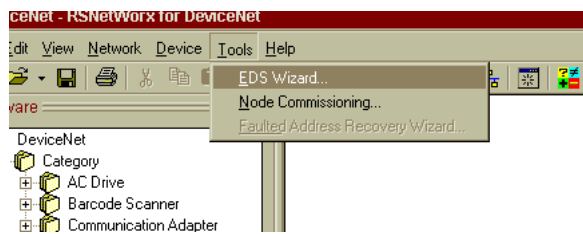

FIG. 110: SELECTING EDS WIZARD

- Step 5. Click on Next. The EDS Options dialog box appears. (See Fig. 112)



FIG. 111: EDS WIZARD DIALOG BOX



FIG. 112: SELECTING "REGISTER AN EDS FILE"

- Step 6. Click on Next. (See Fig. 112) The Registration dialog box appears.
- Step 7. Click on the Browse button. The Select EDS file dialog box appears. Go to the folder that contains the Hardy EDS file. We put the file in the Rockwell Software folder. (See Fig. 113)
- Step 8. Click on the Hardy EDS file to highlight it.
- Step 9. Click on Open. (See Fig. 113)
- Step 10. The Registration dialog box reappears with the path to the Hardy EDS file in the text field. (See Fig. 114)

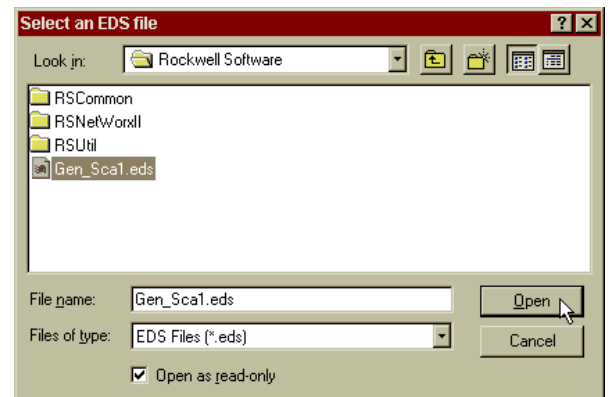

FIG. 113: SELECTING THE HARDY EDS FILE

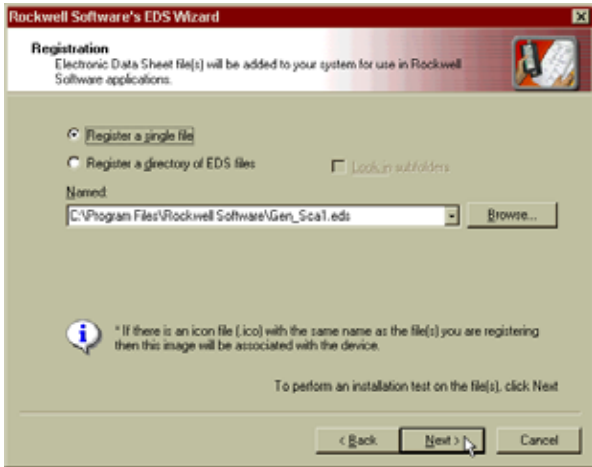

FIG. 114: SELECTING THE HARDY EDS FILE

- Step 11. Click on Next. The EDS File Installation Test Results dialog box appears. (See Fig. 115)
- Step 12. Click on Next. The Change Graphic Image dialog box appears. (See Fig. 116)

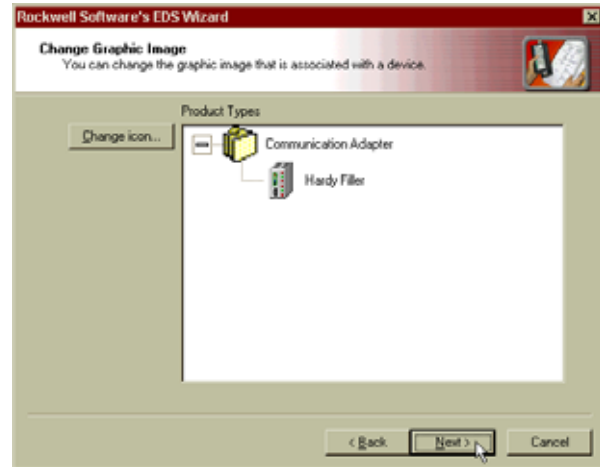

FIG. 116: CHANGE GRAPHIC IMAGE DIALOG BOX

- Step 13. Click on Next. The Final Task Summary dialog box appears. (See Fig. 117)
- Step 14. Click on Next. The main page appears with Hardy listed under Vendor. (See Fig. 118)

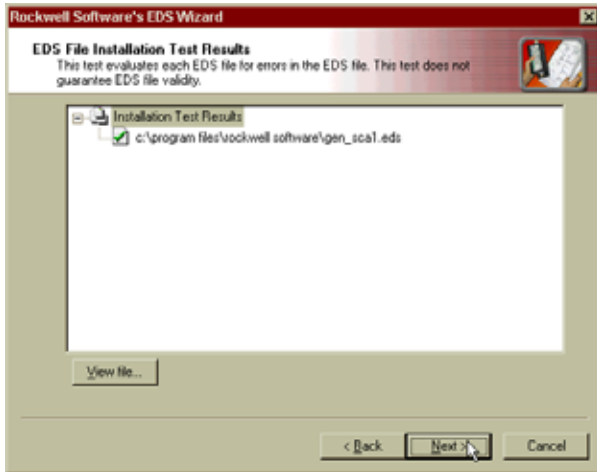

FIG. 115: EDS FILE INSTALLATION TEST RESULTS DIALOG BOX

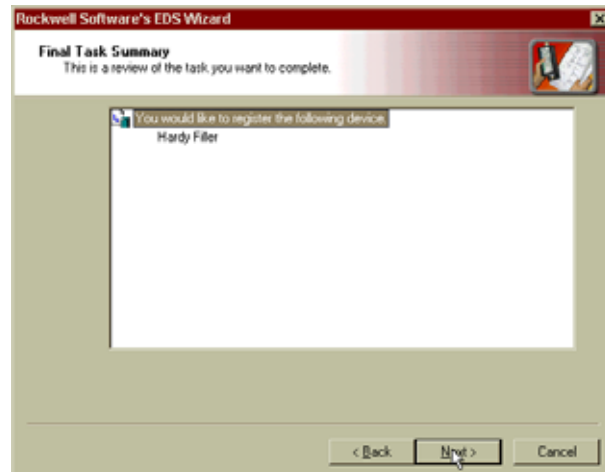

FIG. 117: FINAL TASK SUMMARY DIALOG BOX

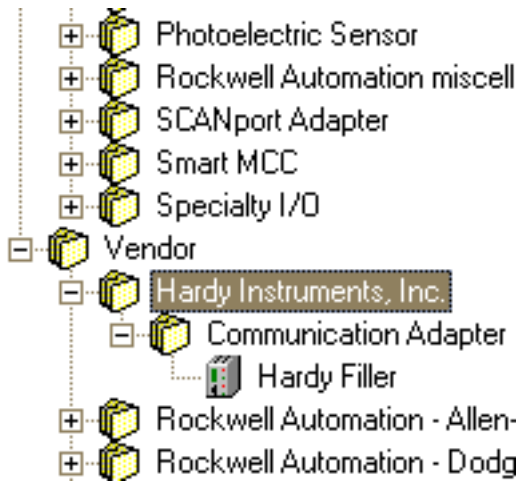

FIG. 118: HARDWARE/VENDOR/HARDY INSTRUMENTS INC. INSTALLED

- Step 15. Click on the graph tab.
- Step 16. Click on the + sign in the box next to Hardy Instruments, Inc. The Communication Adapter folder flies out.
- Step 17. Click on the + sign next to the Communication Adapter and the Hardy Series 3000 Instrument appears next to the Instrument Icon. In our example the Hardy Filler HI-3010.
- Step 18. Double click on the Hardy Filler Icon and it appears in the graph with value 00. (See Fig. 119)
- Step 19. The EDS file installation is complete.

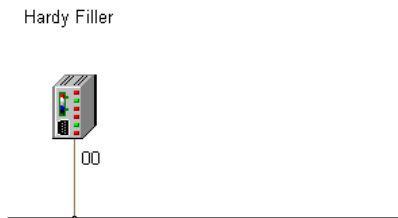

FIG. 119: GRAPH/HARDY FILLER ICON

Slave Mode Setup

The DeviceNet Module can operate in Master or Slave mode. To set the module to the slave mode, perform the following procedures.

- Step 1. Double Click on the Hardy Filler Icon. (See Fig. 119) The Hardy Filler Property List appears with the General Tab selected. (See Fig. 120)
- Step 2. Click on the Module tab.

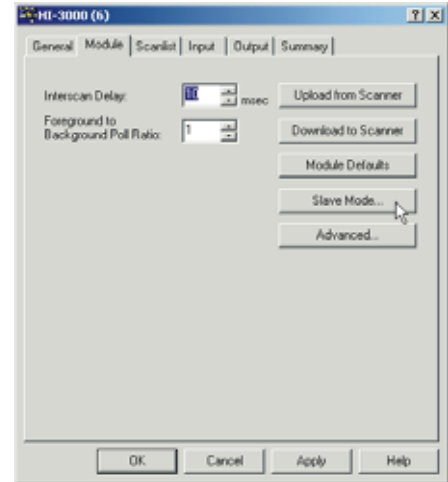

FIG. 120: MODULE TAB/SELECTING SLAVE MODE

- Step 3. Click on the Slave Mode button. (See Fig. 120) The Slave Mode dialog box appears. (See Fig. 121)

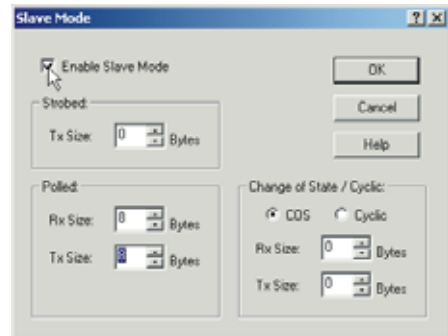

FIG. 121: SLAVE MODE DIALOG BOX

- Step 4. Click in the check box next to "Enable Slave Mode" to enable the Slave Mode.
- Step 5. Under Polled set the number of bytes for the Rx and Tx Sizes.
- Step 6. Click on the OK button.
- Step 7. Click on the Input Tab. The Input Page appears. (See Fig. 122)
- Step 8. Click on the AutoMap button to Map the Inputs. (See Fig. 123)

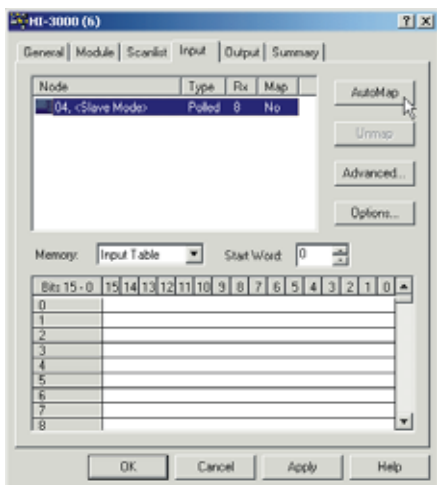

FIG. 122: INPUT PAGE/SELECTING AUTOMAP

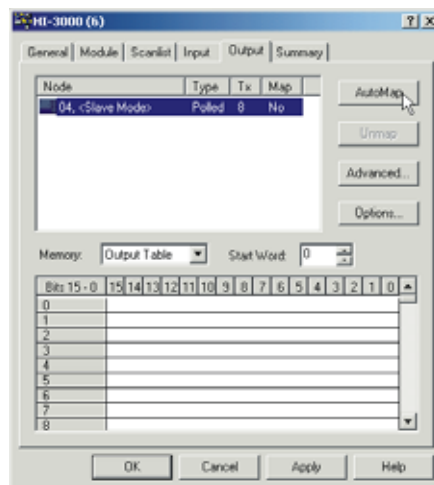

FIG. 124: OUTPUT PAGE/SELECTING AUTOMAP

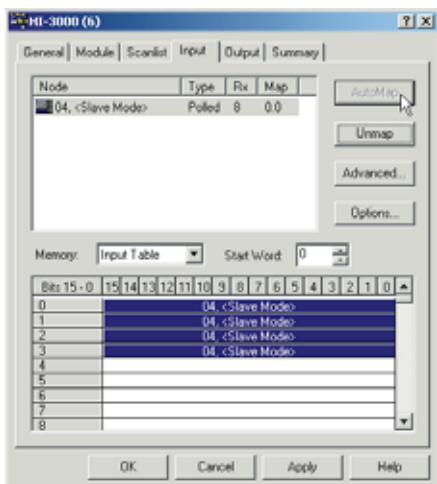

FIG. 123: INPUT PAGE/INPUTS MAPPED

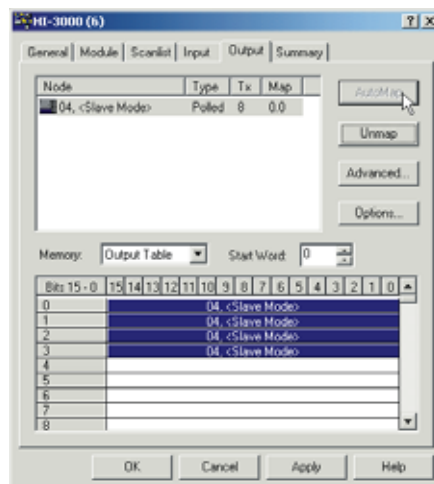

FIG. 125: OUTPUT PAGE/OUTPUTS MAPPED

- Step 9. Click on the Output Tab. The Output Page appears. (See Fig. 124)
- Step 10. Click on the AutoMap button to Map the Outputs. (See Fig. 125)

- Step 11. Click on the OK button to return to the Main Menu. The Slave Mode is set.

Building a Scanlist in RSNetWorx



FIG. 126: GRAPH OF NETWORKED MODULES

- Step 1. Double Click on the Hardy Filler Icon. (See Fig. 126) The Hardy Filler Property List appears. (See Fig. 127) In Properties, you construct the Scanlist, which includes the devices that will be scanned on the network.
- Step 2. Click on the Scanlist tab. The Scanlist page appears. (See Fig. 128)

NOTE: *It is useful to know what you want to configure/map at this point of the setup. See Operating the Instrument Via DeviceNet/Mapping Section in the Individual HI 3000 Series manual(s) for this information.*

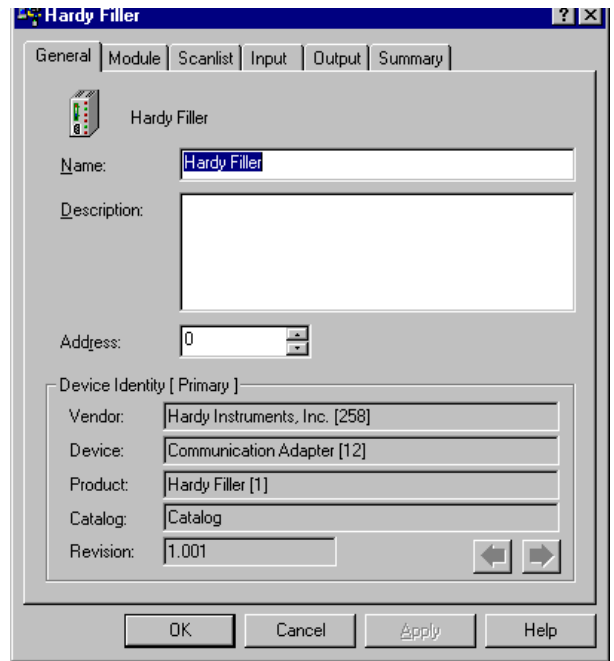

FIG. 127: HARDY FILLER PROPERTIES LIST

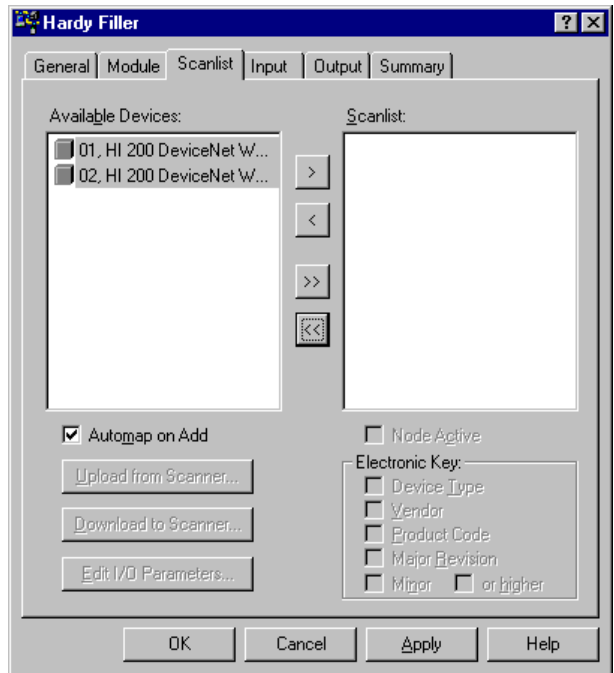

FIG. 128: SCANLIST PAGE/AVAILABLE DEVICES

- Step 3. Notice in the Available Devices field there are two HI 200 DeviceNet Weigh Modules.
- Step 4. Click on the device(s) you want to appear on the scan list.

Step 5. Click on the double arrow pointing to the Scanlist to add the devices to the scanlist. (See Fig. 129)

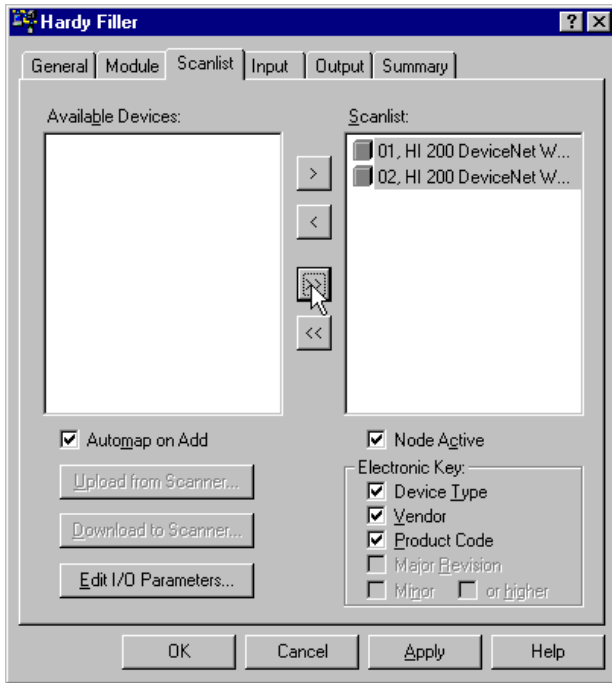

FIG. 129: SCANLIST PAGE/SCANLIST

Step 6. There are a few things on the scanlist page to pay attention to.

- If you want to “Automap on Add”, click on the check box to select this function. This enables the scanlist to be attempted.
- In the Electronic Key area there are three check boxes. When checked, RSNetWorx remembers what version of the device you are adding to the scanlist as well as I/O mapping.

Step 7. Click on the Input Tab. The Input page appears. (See Fig. 130)

Step 8. Here is where you can change the parameters for the devices that the HI 3000 Series device is mapped to. Check your RSNetWorx manual for instructions.

Step 9. Click on OK and the Scanlist configuration is complete.

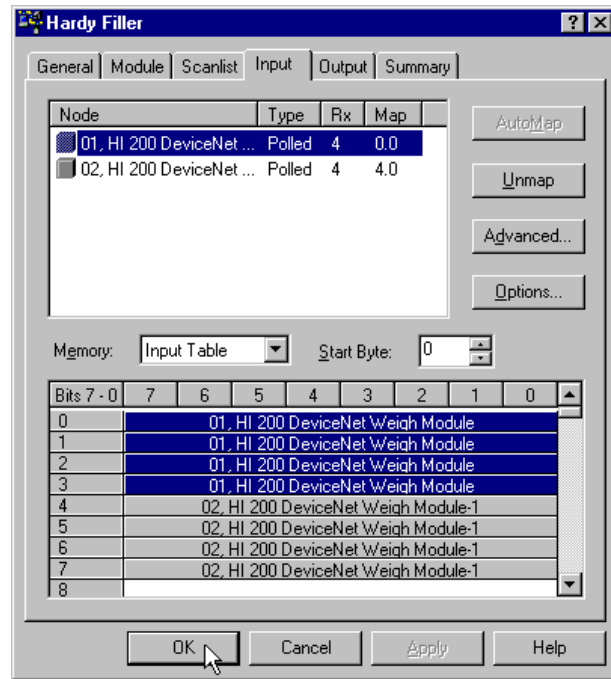

FIG. 130: INPUT PAGE/CHANGE PARAMETERS

ControlNet Network Setup

RSNetWorx Setup for HI 3000 Series Instruments with ControlNet Option Card

Step 1. Download the Hardy EDS file either from the CD that came with your instrument or go to the Hardy Instruments Website to get the most current file. Put the Hardy EDS file in the Rockwell Software folder. **DO NOT PUT THE EDS FILE IN THE EDS FOLDER!**

Step 2. From your computer desktop double click on the RSNetWorx Icon.

Step 3. Click on I/O Configuration/Add New Module

Step 4. Click on Generic ControlNet Module

Step 5. Add the following Information:

- Name - Choose a unique name for the HI 3000 Series module.
- Description - Type in a short description of the module.
- Comm Format - Select Data - INT
- Node - Select the Controlnet node number for the HI 3000 Series module.
- Input:
 - Assembly Instance: 100
 - Size: 127 INT

NOTE: The actual data from the module will always start with word 2 (the third word) of the data. There

are still 125 words but we have adjusted for the first two words which are not available.

- Output:
 - Assembly Instance: 150
 - Size: 125
- Configuration:
 - Assembly Instance: 1
 - Size: 0

Schedule the Network Using RSNetWorx for ControlNet

- Step 1. From your computer desktop double click on the RSNetWorx Icon.
- Step 2. From the Network Menu select New.
- Step 3. Check the Edits Enabled box and go Online.
- Step 4. The Browse the Network window appears with the list of available drivers.
- Step 5. Select the driver (e.g. AB_KTC-1) and click on OK.
- Step 6. If the Online/Offline mismatch alert appears, select the Use online data (upload) option and click on OK.
- Step 7. The “Save As” display appears.
- Step 8. Enter an appropriate name for the ControlNet configuration file and click on Save.
- Step 9. RSNetWorx browses the network for the attached devices and provide a graphic of the devices connected to the network including the HI 3000 Series module.
- Step 10. Verify that the devices and their network node addresses displayed are correct.

Verify the Network Properties

Make sure that the network update time (NUT), Max Scheduled Address, and Max Unscheduled Address are set correctly.

- Step 1. Select Network from the main menu bar and Properties from the pull-down menu. The Network Properties display appears.
- Step 2. Make sure that these parameters are set to the following values:

TABLE 19:

In This Field	Select
Network_Update_Time(ms)	5ms ⁽¹⁾
Max Scheduled Address	10 ⁽²⁾
Max Unscheduled Address	17 ⁽³⁾

NOTE: (1) Remember that the requested packet interval (RPI) for any of the devices on the network cannot be faster than the NUT.

NOTE: (2) This should be set to a value 3 or 4 above the highest scheduled node on the network, in this case the 1756-CNB module at address 6.

NOTE: (3) At a minimum, this should be set to the highest node address on the network, in this case 1784-KTXC15 card at node 17.

Step 3. Click on OK

Survey the Network for Connected Devices

Next have RSNetWorx for ControlNet survey the network for all connected devices.

- Step 1. Check the Edits Enabled box.
- Step 2. From the Selection pull down menu, select Survey Network.
- Step 3. A Network window with the HI 3000 Series Module appears.

Schedule the Network and Save the Configuration

- Step 1. From the Network menu, select Save. The Save Configuration display appears.
- Step 2. Click in the “Optimize and re-write schedule for all connections” radio button and click OK.
- Step 3. The network is now configured and scheduled and the local controller is able to communicate with the remote HI 3000 Series device.

Selecting the ControlNet Node Address from the Front Panel

- Step 1. At the front panel click on the Setup/3 button. The Configuration Menu appears. (See Fig. 131)

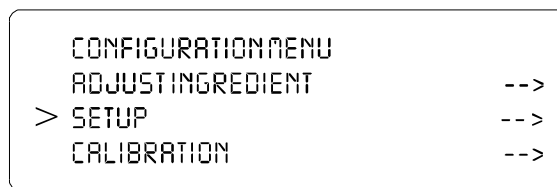

FIG. 131: CONFIGURATION MENU/SELECTING SETUP

- Step 2. Push the up or down arrows until the cursor is next to “OPTIONS”. (See Fig. 132)

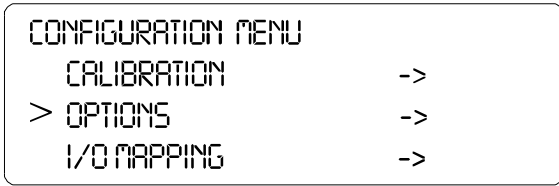

FIG. 132: CONFIGURATION MENU/SELECTING OPTIONS

- Step 3. Press the Enter button. The Options submenu appears with Remote I/O selected. (See Fig. 133)
- Step 4. If the cursor is not in front of ControlNet I/O, push the up arrow until the cursor is aligned with ControlNet I/O. (See Fig. 133)
- Step 5. Press the Enter button. The ControlNet I/O Menu appears. (See Fig. 134)

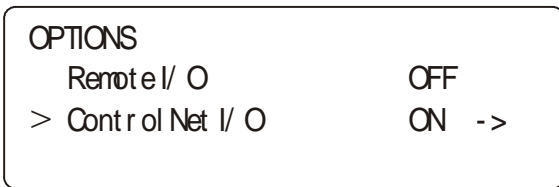

FIG. 133: OPTIONS/SELECTING REMOTE I/O

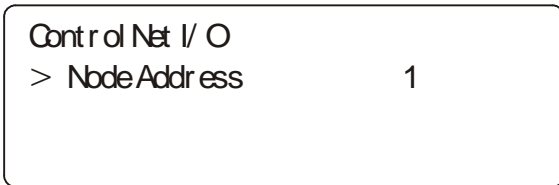

FIG. 134: CONTROLNET I/O MENU/SELECTING THE NODE ADDRESS

- Step 6. Press the left or right arrow buttons to select the node address of this instrument. (See Fig. 134)
- Step 7. Press the Enter button to set the entry.
- Step 8. Press the Exit button until the Main Menu appears.

Selecting the ControlNet Node Address from the Web Page

- Step 1. From the Home page of the HI 3000 Instrument, click on Configuration. (See Fig. 135) The Configuration Page appears. (See Fig. 136)



FIG. 135: ELECTING CONFIGURATION FROM THE HOME PAGE OF THE HI 3000 INSTRUMENT

Configuration

- [Adjust Setpoint](#)
- [Instrument Setup](#)
- [Calibration](#)
- [Basic Mapping](#)
- [Advanced Mapping](#)
- [Security](#)
- [Options](#)

FIG. 136: CONFIGURATION PAGE/SELECTING OPTIONS

- Step 2. Click on Options. (See Fig. 179) The Configuration-Options appears listing the option cards that are installed in this instrument. (See Fig. 137)

Configuration - Options

[Smart diagnostic card configuration](#)

[View ControlNet Configuration](#)

FIG. 137: CONFIGURATION - OPTIONS/SELECTING VIEW CONTROLNET CONFIGURATION OPTION

Step 3. Click on View ControlNet Configuration. (See Fig. 137) The ControlNet Configuration Page appears. (See Fig. 138)

ControlNet Configuration

Node:



FIG. 138: CONTROLNET CONFIGURATION PAGE/ SELECTING THE NODE ADDRESS

Step 4. Double Click in the Node: Text field. (See Fig. 138) Enter the node address of this HI 3000 instrument. (Node Address Range: 0-99)

Step 5. Click on Set Parameters. The Node address is set for this instrument.

PROFIBUS-DP Network Setup



FIG. 139: PROFIBUS LOGO

NOTE: Hardy Process Solutions is a member of Profibus International.

Initialization Process

To be able to add an HI 3000 Series Instrument to a Profibus-DP network, you need a PC and software such as Siemens Step 7™, Simatic Manager or equal, that allows the Profibus-DP PLC and the HI 3000 Series Instrument to exchange data. Profibus Specifications are located in the Installation and Service Manual for each HI 3000 Series Instrument.

Profibus-DP .GSD File

All devices connected to a Profibus-DP network requires a *.gsd file. The *.gsd file contains all the parameters including the baud rate, table formats and necessary data required by the network PLC when an HI 3000 Series Instrument is connected to the network.

A copy of the *.gsd file can be found on the CD that comes with the instrument or at the Hardy Website or at <http://www.profibus.com/libraries.html>.

Whichever Simatic Manager you select, you must go through these three steps:

- Step 1. Connect the HI 3000 Series Instrument to the Profibus DP network and verify the address. (See Fig. 140) (Installation and Cabling Instructions are located in the Cabling Section of this Manual)
- Step 2. Connect the PC to the Trunk Line. Load the configuration properties to the initialization software on the PC and transfer them to the PLC.
- Step 3. Install the *.gsd file, and map I/O data table properties to the instrument.

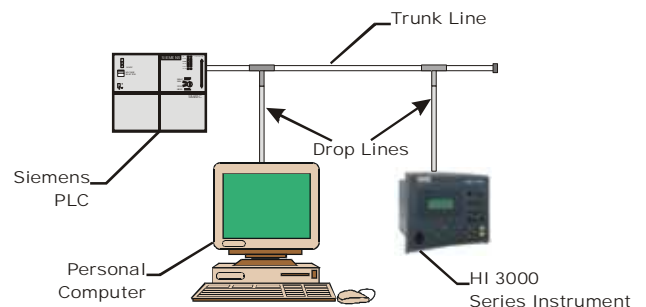

FIG. 140: SIMPLE PROFIBUS NETWORK WITH TRUNK AND DROP LINES

Pre-Initialization Procedures

Step 1. Inspect the network cables and make sure that the cables have been installed correctly and satisfy the Profibus-DP guidelines for the data transmission baud rate(s) required. (See the Cabling Chapter/ Profibus Installation in this manual for Profibus-DP cable specifications and cabling guidelines.)

- Step 2. Select the Node address for the HI 3000 Series. (See below) This can be done before or after Initialization.
- Step 3. Cycle power, or perform the two previous steps before powering up your network. Address selection can only occur after cycling the power. Make sure that the software you use will detect the values as you have set them.

CAUTION: THE ADDRESS SHOULD NEVER BE CHANGED DURING OPERATION. IF THE ADDRESS IS MODIFIED WHILE THE POWER IS ON, AN INTERNAL ERROR COULD BE GENERATED AND THE MODULE DISCONNECTED FROM THE NETWORK.

NOTE: Profibus-DP provides a very flexible network solution. In addition to the basic guideline provided in this manual, your installation could require procedures that are beyond the scope of this manual. For more information and to locate lists of links to other sources of Profibus-DP information, check the Profibus website at <http://www.profibus.com>.

- Step 4. Complete any additional configuration that is required by your PLC for initialization. Our initialization example is for a Siemens PLC. Your PLC initialization requirements may differ.
- Step 5. Install the *.GSD file for the HI 3000 Series Instrument you connected to the Profibus Network.

Initialization Procedures

NOTE: The examples provided are taken from the Siemens Step 7™, Simatic Manager Software. Your software will vary from these procedures. Step 7™ is a trademark of the Siemens Corporation.

- Step 1. In the Siemens Step 7™, Simatic Manager open the Hardware Catalog. (See Fig. 141)

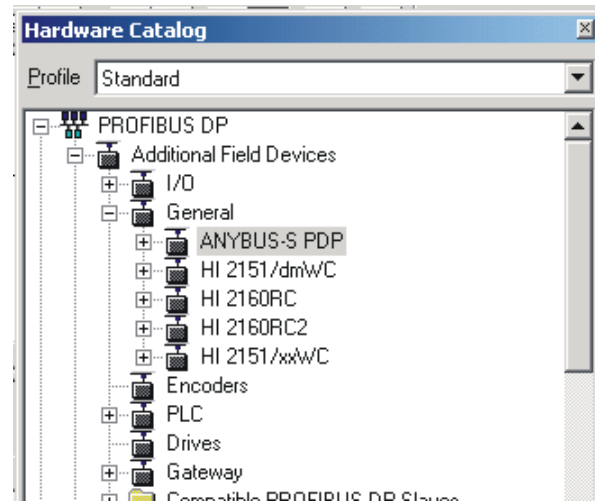

FIG. 141: HARDWARE CATALOG/SELECTING ANYBUS-S PDP FOLDER

- Step 2. Click on the “+” to expand the Additional Field Devices Folder. (See Fig. 141)
- Step 3. Click on the “+” to expand the General Folder. (See Fig. 141)
- Step 4. Highlight the CPU you selected in the UR dialog box.
- Step 5. Double Click on ANYBUS-S PDP or drag and drop the ANYBUS-S PDP folder to the Profibus-DP Network. The Parameters dialog box appears. (See Fig. 142)
- Step 6. You can set the address of the instrument here if necessary.

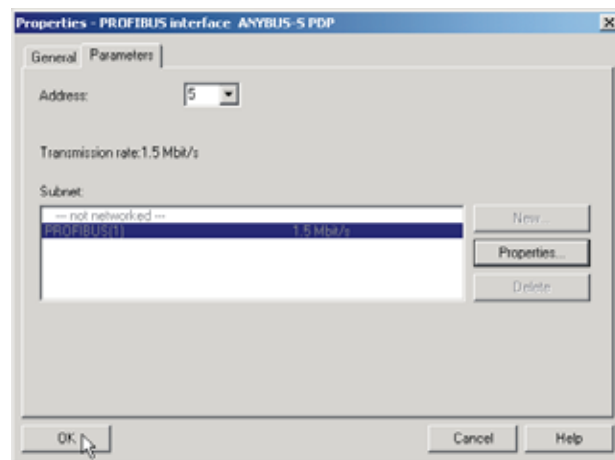

FIG. 142: ANYBUS-S PDP PARAMETERS DIALOG BOX

- Step 7. Click on “+” to expand the ANYBUS-S PDP folder. (See Fig. 143)

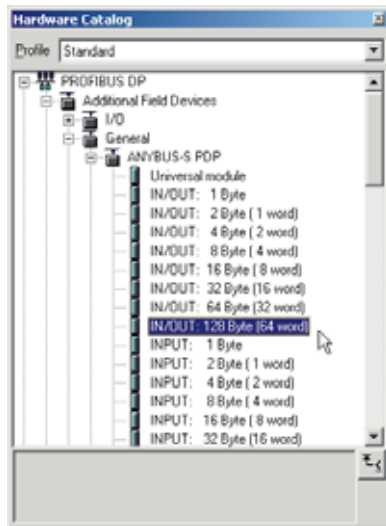

FIG. 143: SELECTING THE INPUT AND OUTPUT SIZE

NOTE: The HI 3000 Series Input and Output Sizes are expressed in words. Many of the Profibus Network Management software Input and Output Sizes are expressed in bytes. Make sure that the Input/Output selection matches the Input and Output Sizes of the HI 3000 Series Instruments.

- Step 8. Select the Input and Output Sizes that match the Input and Output Size setup in the HI 3000 Series Instrument. You can also use a combination of selections that add up to the desired length. The Output and Input Sizes have a range from 0 to 122 words. The combined Output and Input Sizes cannot exceed 208 words.
- Step 9. In our example the Input and Output Size set in the HI 3000 Series instrument is 64 words. In this case the Input and Output Sizes are equal so we selected the IN/OUT:128Byte (64 word).
- Step 10. Highlight Slot 1. Double click on IN/OUT:128Byte (64 word). The Input and Output appear in Slot 1 and Slot 2 listing the Module, Order Number and the I Address (Input Address) and Q Address (Output Address).
- Step 11. The HI 3000 Series (ANYBUS) module appears in the Profibus Network. (See Fig. 144)

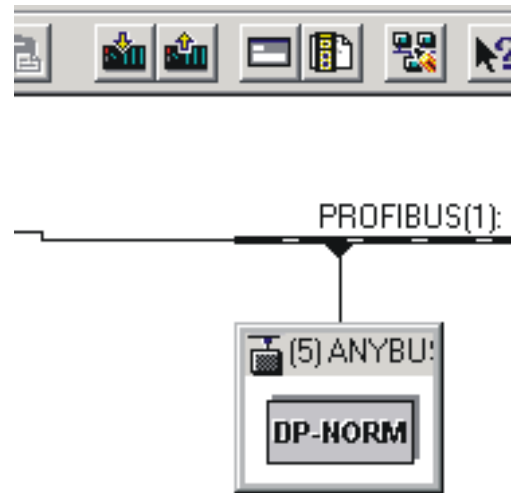

FIG. 144: ANYBUS-S PDP APPEARS IN THE NETWORK

- Step 12. Click on the Down Load Icon to download the configuration to the PLC. (See Fig. 145) The Select Destination Module dialog box appears. (See Fig. 146)

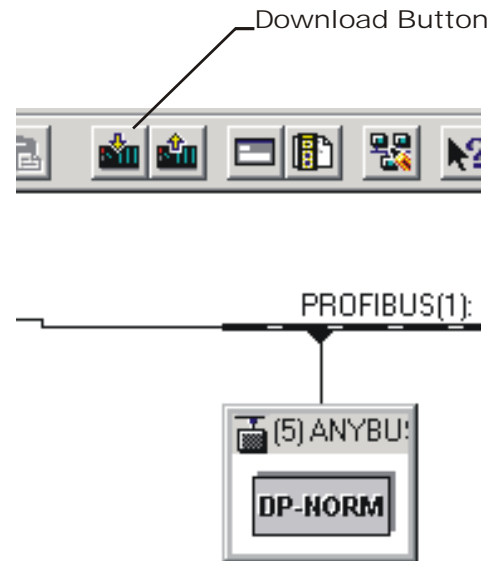

FIG. 145: DOWNLOADING HI 3000 SERIES CONFIGURATION

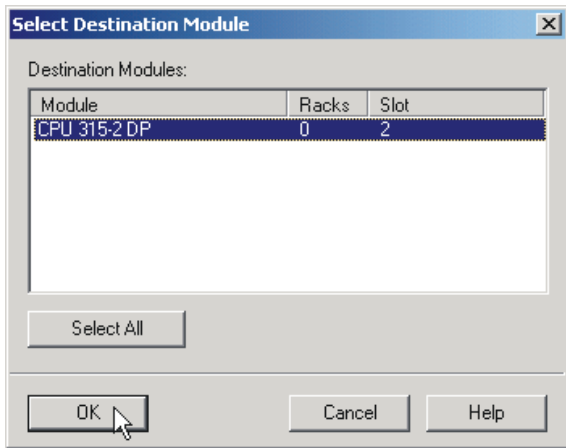

FIG. 146: SELECT DESTINATION MODULE DIALOG BOX

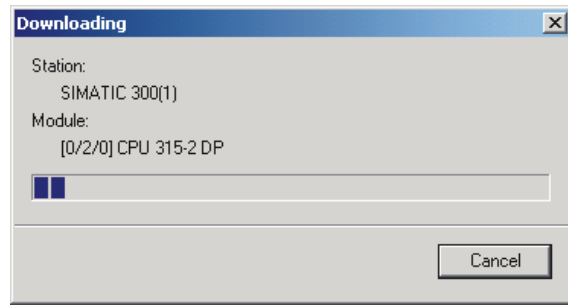

FIG. 148: DOWNLOADING CONFIGURATION PROMPT

Step 13. Click on OK. The Select Station Address Dialog box appears. (See Fig. 147)

Step 15. When the download is complete the HW Config dialog box should look something like this. (See Fig. 149)

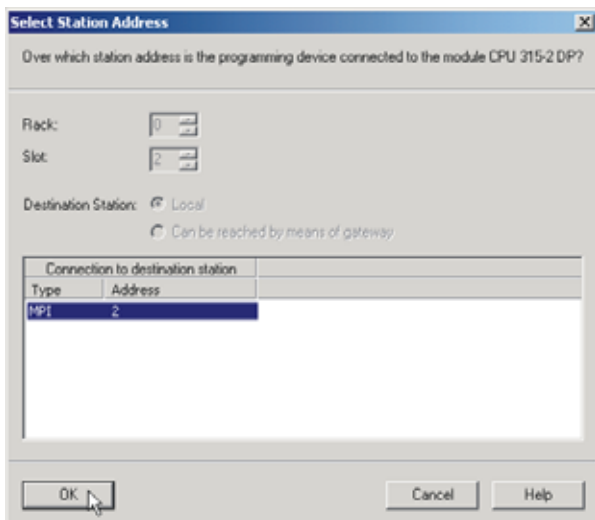

FIG. 147: SELECT STATION ADDRESS DIALOG BOX

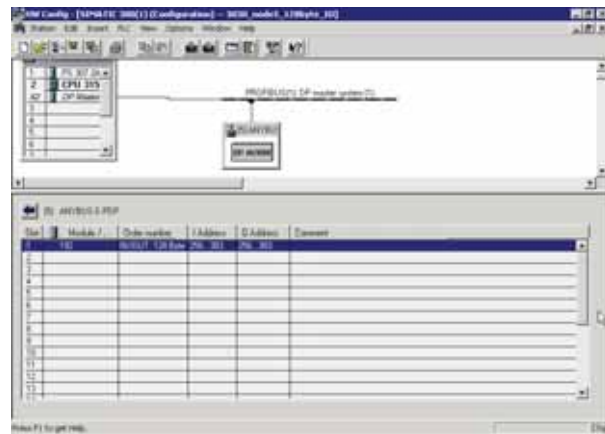

FIG. 149: INITIALIZATION COMPLETE

Step 14. Click on OK. A prompt appears indicating that the Step 7 is downloading the configuration to the PLC. (See Fig. 148)

Step 16. Initialization is complete.

Selecting the Profibus Node Address from the Front Panel

Step 1. At the front panel click on the Setup/3 button. The Configuration Menu appears. (See Fig. 150)

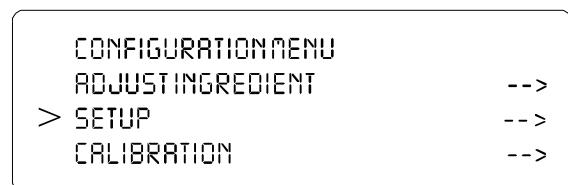

FIG. 150: CONFIGURATION MENU/SELECTING SETUP

Step 2. Push the up or down arrows until the cursor is next to “OPTIONS”. (See Fig. 151)

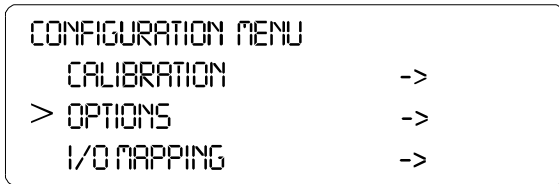

FIG. 151: CONFIGURATION MENU/SELECTING OPTIONS

- Step 3. Press the Enter button. The Options submenu appears with Remote I/O selected. (See Fig. 198)
- Step 4. If the cursor is not in front of Profibus I/O, push the up arrow until the cursor is aligned with Profibus I/O.
- Step 5. Press the Enter button. The Profibus I/O Menu appears. (See Fig. 153)

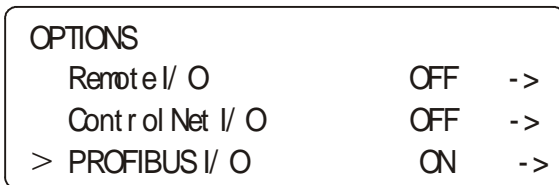

FIG. 152: OPTIONS/SELECTING PROFIBUS I/O

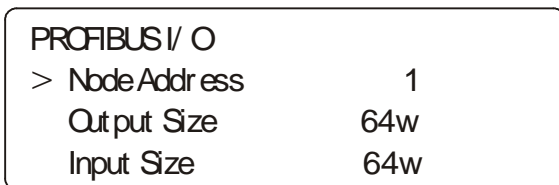

FIG. 153: PROFIBUS I/O MENU/SELECTING THE NODE ADDRESS

- Step 6. Press the left or right arrow buttons to select the node address of this instrument or enter the address.
- Step 7. Press the Enter button to set the entry.
- Step 8. Press the down arrow button until the cursor is in front of Output Size. The Output and Input Sizes have a range from 0 to 122 words. The combined Output and Input Sizes cannot exceed 208 words.
- Step 9. Press the left or right arrows to increase or decrease the Output Size or enter the value.

NOTE: The HI 3000 Series Input and Output Sizes are expressed in words. Many of the Profibus Network Management software Input and Output Sizes are expressed in bytes. Make sure that the

Input/Output selection matches the Input and Output Sizes of the HI 3000 Series Instruments.

- Step 10. Press the Enter button to set the entry.
- Step 11. Press the down arrow button until the cursor is in front of Input Size.
- Step 12. Press the left or right arrows to increase or decrease the Input Size or enter the value.
- Step 13. Press the Enter button to set the entry.
- Step 14. Press the Exit button until the Main Menu appears.
- Step 15. Cycle the power.

Selecting the Profibus Node Address from the Web Page

From the Home page of the HI 3000 Instrument, click on Configuration. (See Fig. 154) The Configuration Page appears. (See Fig. 155)



FIG. 154: SELECTING CONFIGURATION FROM THE HOME PAGE OF THE HI 3000 INSTRUMENT

Configuration

[Adjust Setpoint](#)

[Instrument Setup](#)

[Calibration](#)

[Basic Mapping](#)

[Advanced Mapping](#)

[Security](#)

[Options](#)

FIG. 155: CONFIGURATION PAGE/SELECTING OPTIONS

Step 16. Click on Options. (See Fig. 155) The Configuration-Options appears listing the option cards that are installed in this instrument. (See Fig. 156)

Configuration - Options

[Scale/Channel Card Configuration](#)

[View Profibus Configuration](#)

[View DeviceNet Configuration](#)



FIG. 156: CONFIGURATION - OPTIONS/SELECTING VIEW PROFIBUS CONFIGURATION OPTION

Step 17. Click on View Profibus Configuration. (See Fig. 156) The Profibus Configuration page appears. (See Fig. 157)

Profibus Configuration

Node:

Output Table Size (words):

Input Table Size (words):



FIG. 157: PROFIBUS CONFIGURATION PAGE/ SELECTING THE NODE ADDRESS

- Step 18. Double Click in the Node: Text field. (See Fig. 157) Enter the node address of this HI 3000 instrument. (Node Address Range: 0-99)
- Step 19. Double Click in the Output Table Size (words): Text Field. Enter the Output Table Size for your application. Default is 64 words.
- Step 20. Double Click in the Input Table Size (words): Text field. Enter the Input Table Size for your application. Default is 64 words.
- Step 21. Click on Set Parameters. The Node address is set for this instrument.
- Step 22. Tap on Left or Right until the node address you want for this instrument appears.

- Step 23. Tap on Enter to set the entry. (See Fig. 207)
- Step 24. Tap on Down to move the cursor in front of Output Size. The Output and Input Sizes have a range from 0 to 122 words. The combined Output and Input Sizes cannot exceed 208 words.
- Step 25. Tap on Right or Left to increase or decrease the Output size.

NOTE: The HI 3000 Series Input and Output Sizes are expressed in words. Many of the Profibus Network Management software Input and Output Sizes are expressed in bytes. Make sure that the Input/Output selection matches the Input and Output Sizes of the HI 3000 Series Instruments.

- Step 26. Tap on Enter to set the entry. (See Fig. 207)
- Step 27. Tap on Down to move the cursor in front of Input Size.
- Step 28. Tap on Right or Left to increase or decrease the Input size.
- Step 29. Tap on Enter to set the entry.
- Step 30. Tap on Exit to return to the Main Menu.

MODBUS - TCP/IP Over Ethernet

About MODBUS/TCP/IP Over Ethernet

MODBUS is an application layer messaging protocol, positioned at level 7 of the OSI model, that provides client/server communication between devices connected on different types of buses or networks. Support for the simple and elegant structure of MODBUS continues to grow. The Internet community can access MODBUS at a reserved system port 502 on the TCP/IP stack.

MODBUS is a request/reply protocol and offers services specified by function codes. MODBUS function codes are elements of MODBUS request/reply PDUs. The objective of this document is to describe the function codes used within the framework of MODBUS transactions.

MODBUS is an application layer messaging protocol for client/server communication between devices connected on different types of buses or networks. (See Fig. 159)

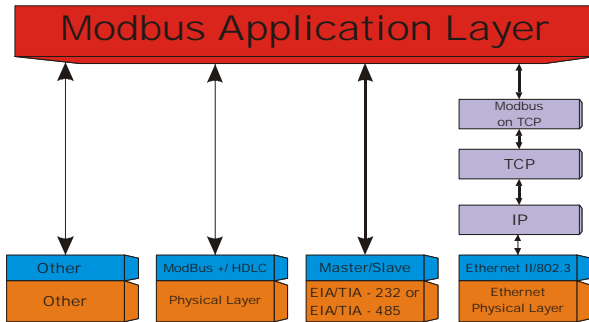

FIG. 158: MODBUS COMMUNICATION DIAGRAM

It is currently implemented for the HI 3000 product line using:

1. TCP/IP over Ethernet.

Installing MODBUS

Enabling MODBUS in the HI 3000 Module

MODBUS is an optional network communication protocol and requires a Key to enable. You can purchase the option with the Key by contacting your local Hardy Instruments Representative or Hardy Instruments Customer Service.

- Step 1. From the HI 3000 module home page, click on Configuration. (See Fig. 159) The Configuration Page appears. (See Fig. 160)



FIG. 159: MACHINE MONITOR/SELECTING CONFIGURATION

Configuration

- [Instrument Setup](#)
- [Expansion Channels](#)
- [Control Link](#)
- [Mapping](#)
- [Security](#)
- [Email](#)
- [Options](#)

FIG. 160: CONFIGURATION/SELECTING OPTIONS

- Step 2. Click on Options. The Configuration - Options page appears. (See Fig. 161)

Configuration - Options

- [View ControlNet Configuration](#)
- [View DeviceNet Configuration](#)
- [Modbus](#)
- Slot 3: [View Acceleration/Velocity Card Configuration](#)
- Slot 4: [View Rod Drop Card Configuration](#)
- Slot 7: [View Impact Card Configuration](#)
- Slot 8: [View Acceleration/Velocity Card Configuration](#)

FIG. 161: CONFIGURATION - OPTIONS/SELECTING MODBUS

- Step 3. Click on Modbus. MODBUS-Options page appears. (See Fig. 162)



FIG. 162: MODBUS - OPTIONS PAGE

- Step 4. Click on the Modbus pull down list.
- Step 5. Select ON.
- Step 6. Click in the Modbus Key text field.
- Step 7. Enter the Modbus Key.

- Step 8. Click on the Set Parameter button.
- Step 9. This procedure activates the Modbus option on in the instrument.
- Step 10. The HI 3000 module is Modbus enabled. (See Fig. 163)



FIG. 163: MODBUS - OPTIONS/ENABLED]

- Step 11. You can now map from your client (PLC) to the HI 3000 module via Modbus.

Installing Hardy Modbus-Link

If you do not have a PLC or other client, Hardy has provided the Hardy Modbus-Link Client to communicate with the HI 3000 module. For the sake of clarity the Client/Server definitions are as follows:

- Client - The module asking for data.
- Server - The module providing the data.

The Hardy Modbus-Link will not work without the key. To purchase the Modbus Option with the key, contact your local Hardy Instruments Representative or Hardy Instruments, Customer Service.

- Step 1. On the Documentation CD you received with your HI 3000 Instrument you will find a copy of the Hardy Modbus-Link Software. If you do not have the CD that came with your instrument you can go to the HI 3000 Resources Web page and download the application from there.
- Step 2. Double click on the Hardy Modbus-Link .exe file to install the software on your PC. Once the Installation is complete a Hardy Modbus-Link icon appears on your Desktop.
- Step 3. Double click the Hardy Modbus-Link icon. The Hardy Modbus-Link display appears. (See Fig. 164)



FIG. 164: HARDY MODBUS-LINK DISPLAY

- Step 4. Click on the Connection pull down menu. (See Fig. 165)



FIG. 165: HARDY MODBUS-LINK/SELECTING CONNECT

- Step 5. Click on "Connect", the TCP/IP Connection display appears. (See Fig. 166)
 - If TCP/IP is not selected, click on the pull down list and select it. (See Fig. 167)

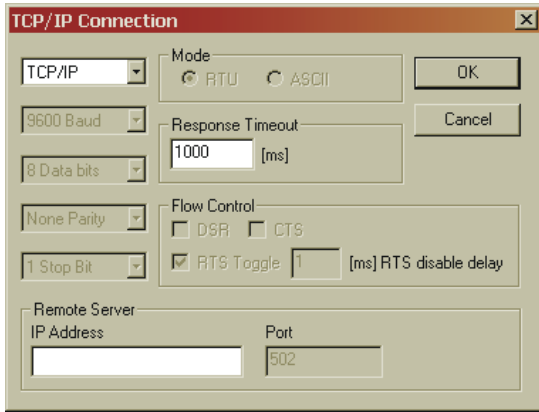
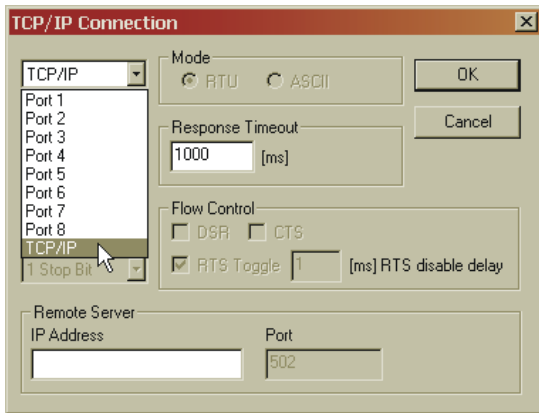
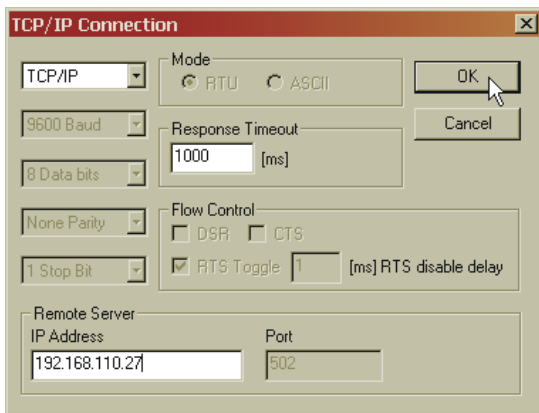

FIG. 166: TCP/IP CONNECTION DISPLAY



**FIG. 167: TCP/IP CONNECTION DISPLAY/
SELECTING TCP/IP**

Step 6. Click in the IP Address text field and type in the IP address of the HI 3000 module you want to communicate with. (See Fig. 168)



**FIG. 168: TCP/IP CONNECTION DISPLAY/
ENTERING THE IP ADDRESS**

Step 7. Click on OK. The red “No Connection” disappears and the values at the top of the page start to change.

Step 8. You are now connected from your PC to the HI 3000 module.

Step 9. To verify that you have two (2) way communication do the following:

- From the Mapping web page of the HI 3000 instrument you want to communicate with, click on the Scratchpad pull down menu. (See Fig. 169)
- Click on “Float Variable 4”.
- Click on the Select button. “HFO4=” appears in the Map: text field. (See Fig. 170)

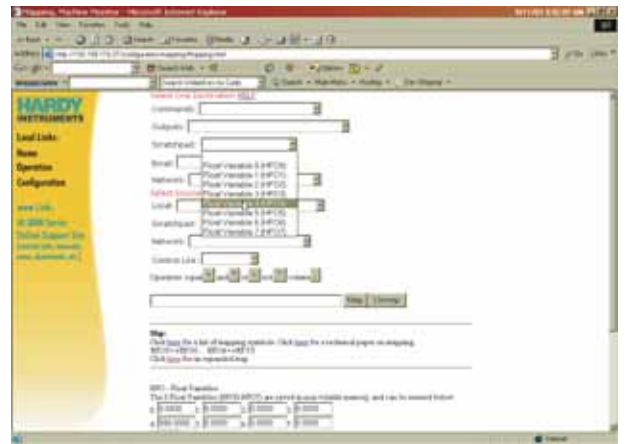

**FIG. 169: MAPPING DISPLAY/CLICKING ON
DESTINATION - SCRATCHPAD: HFO4 (HARDY
FLOAT OUT - WORD 4)**

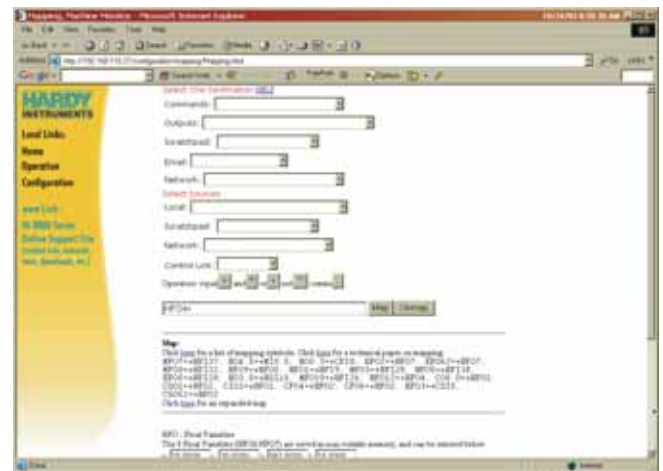

**FIG. 170: MAPPING DISPLAY/SELECTING
DESTINATION - SCRATCHPAD: HFO4**

- Click on the Network pull down list.

- Click on Modbus Float In (MFIO). (See Fig. 171)
- Keep the default word 0.
- Click on the Select button. The Destination and Source appear in the Map: text field. (HFO4=MFIO)

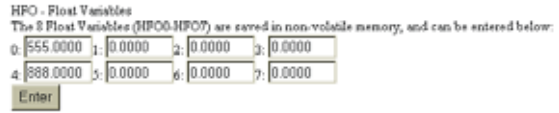

FIG. 173: MAPPING DISPLAY/HFO - FLOAT VARIABLES/ENTERING A VALUE FOR WORD 0

- Click on the Enter button.
- Go to the Hardy Modbus-Link Display. (See Fig. 174) Minimize the Web Page, do not close the browser.

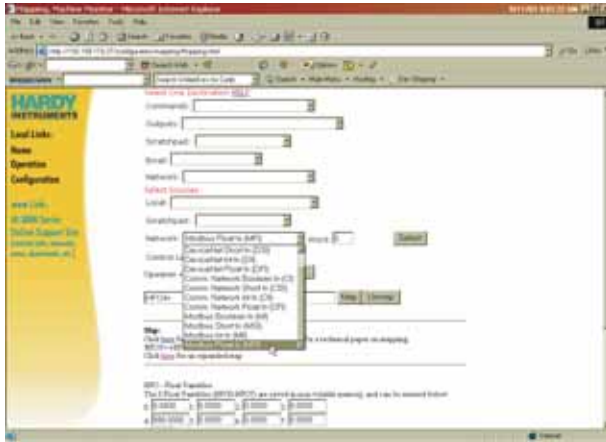

FIG. 171: MAPPING DISPLAY/SELECTING SOURCE - MFIO (MODBUS FLOAT IN - WORD 0)

- Click on the Map button. The Destination and Source are mapped to the HI 3000 module. To recap we mapped the Modbus Float In, word 0 to Hardy Float Out, Word 4). (See Fig. 172)



FIG. 174: HARDY MODBUS-LINK DISPLAY/ SELECTING DISPLAY/FLOAT INVERSE

- Click on the Display pull down menu. (See Fig. 174)
- Click on Float Inverse. The value we entered from the Mapping page appears to the right of the “00000 =” which is “555.0000” (See Fig. 175)

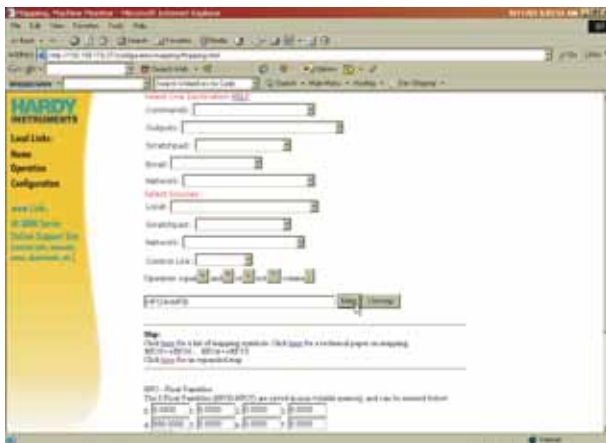

FIG. 172: MAPPING DISPLAY/MAPPING THE SOURCE TO THE DESTINATION

- Double click in the HFO (Hardy Float Out) text field 0.
- Type in a value. For our example we used the value “555.0000”. (See Fig. 173)



FIG. 175: HARDY MODBUS-LINK DISPLAY/555.0000 APPEARS

- Click on button 23, (See Fig. 176) the Read/Write Multiple Registers. The Write multiple registers display appears. (See Fig. 177)

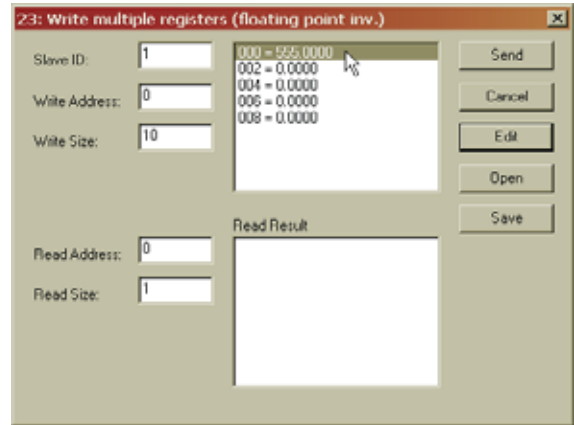

FIG. 177: HARDY MODBUS-LINK DISPLAY/WRITER MULTIPLE REGISTERS DISPLAY

- Double click on “555.0000”. (See Fig. 177) The Enter Value display appears with the value 555 which was sent from the HI 3000 module. (See Fig. 178)

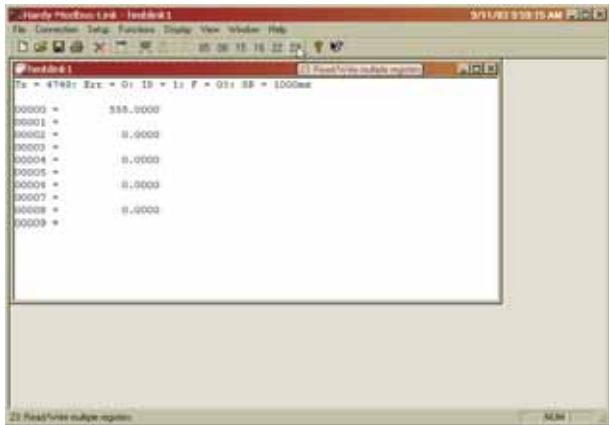

FIG. 176: HARDY MODBUS-LINK DISPLAY/SELECTING BUTTON 23 - READ/WRITE MULTIPLE REGISTERS



FIG. 178: HARDY MODBUS-LINK/ENTER VALUE DISPLAY

Step 10. Double click in the text field to highlight the value. In our example “555”.

Step 11. Enter a new number. We entered “999”. (See Fig. 179)

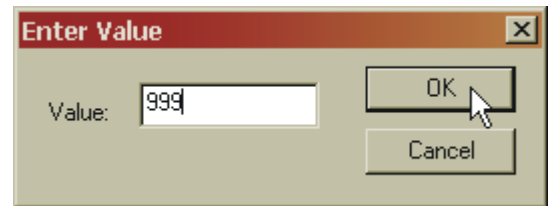

FIG. 179: HARDY MODBUS-LINK/ENTER VALUE DISPLAY/ENTERING 999

Step 12. Click on OK. The Write Multiple Registers display appears with “999.0000” in place of “555.0000”. (See Fig. 180)

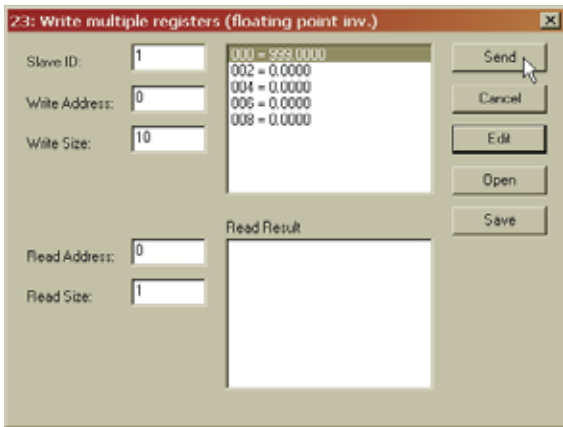

FIG. 180: HARDY MODBUS-LINK/WRITE MULTIPLE REGISTERS/SENDING NEW VALUE

Step 13. Click on the Send button. A Response pop up appears indicating that the Response from the HI 3000 module was received. (See Fig. 181)



FIG. 181: RESPONSE OK POP UP

- Click on OK.

Step 14. In the event you get an error message, check the following:

- Function Not Supported - Does not allow you to use the selected function. Use a different function.
- Address Error - Wrong IP address of the register you want to send the data. Get and enter the correct IP address. You can get the correct IP address from your Network Administrator.
- Byte Count Error - The Byte count is incorrect. Enter the correct byte count.
- Value Error - The Value entered does not match the variable type. Enter the correct value that is equal to or less than the variable type.
- Request Error - You want to Read and you select Write. Make sure you select the correct Request Error.

Step 15. Go to the Mapping Display of your HI 3000 module. The value “999.0000” appears in the HFO - Float Variables, word 4. (See Fig. 182)

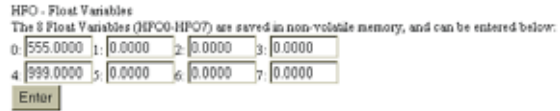

FIG. 182: MAPPING DISPLAY WITH VALUE “999.0000” RECEIVED FROM THE HARDY MODBUS-LINK CLIENT

Step 16. This verifies that you have two way communication between the Client (Hardy Modbus-Link) and the Server (HI 3000 Module). You are now able to Write and Read values from/to the HI 3000 Instrument.

NOTE: For more examples please check the Documentation CD you received with your instrument. You will find tutorials in the ModBus/Tutorials folder.

Step 17. For information about setting up communication from your Modbus Client please refer to the documentation that came with your Client.

Step 18. If you want more Mapping information for your HI 3000 instrument, consult the Service Manual for the module you purchased.

Using MODBUS with Excel®

MODBUS can connect to an Excel spreadsheet for monitoring. If you have Excel installed on your computer, just do the following:

- Step 1. Open the 3600 modbus.xls file in the MODBUS folder on the Documentation CD that came with your HI 3000 Series instrument.
- Step 2. Click on the Enable Macros button.
- Step 3. Click on the Start Modbus button.
- Step 4. If you have lost your CD, From your Machine Monitor Home Page, Click on the HI 3000 Series Online Support.
- Step 5. Click on Support.
- Step 6. Click on Sample Programs.
- Step 7. Download the 3600 modbus.xls file to your computer.

OPC Network Setup

OLE for Process Control (OPC) enables an HI 3000 module to communicate with any device that supports OLE/COM. The architecture is designed to utilize the Microsoft distributed OLE technology (DCOM) to facilitate clients interfacing to remote servers. (See Fig. 183)

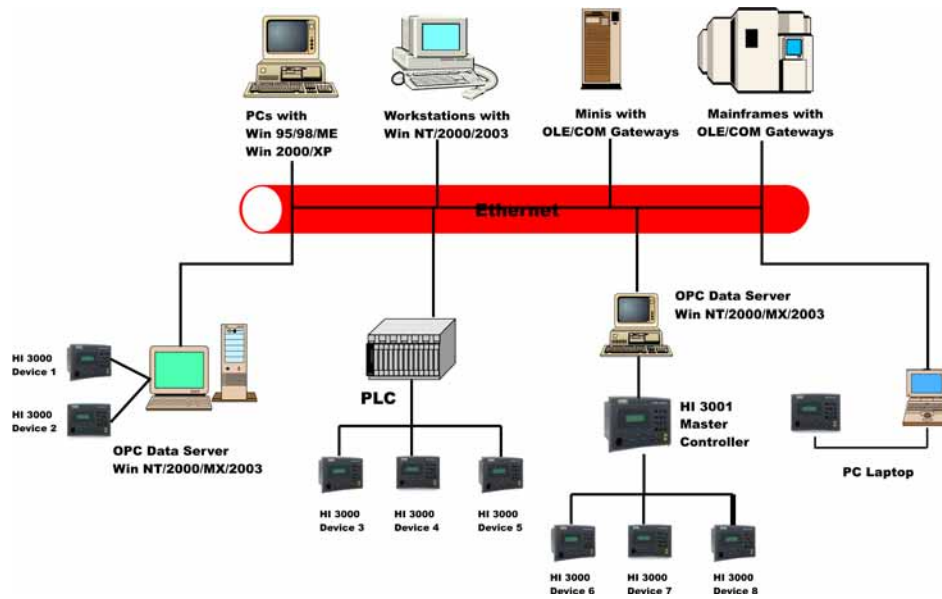

FIG. 183: OPC HETEROGENEOUS COMPUTING ENVIRONMENT

OPC SERVER

The Hardy OPC server is an optional communication network software package that is a configurable I/O server designed to transfer data between your data collection and display software and the Hardy HI 3000 modules. (See Fig. 233) To purchase the OPC server option, contact your local Hardy Representative or Hardy Instruments Customer Service.

Installation instructions are provided with the OPC Server software. Refer to the OPC I/O Server Quick Start Manual to install and configure the I/O server. Remember the OPC Server is just that, a Server. Nothing will happen unless a client asks for information. Some client application must be present and asking for information. (See Fig. 184)

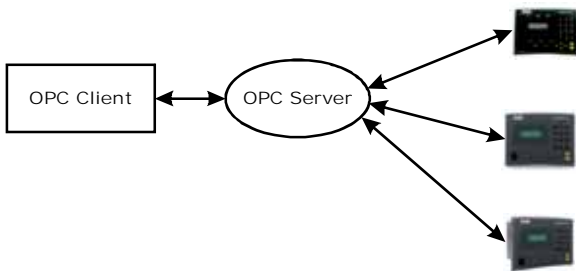

FIG. 184: OPC CLIENT/SERVER/ITEMS

Configuring Omniserver to Communicate with an HI 3000 Module

Winsock Configuration

Step 1. Once you have installed the Descartes Omniserver™ OPC Server, click on Start.

NOTE: Descartes Omniserver™ is the trademark of Descartes Systems Sciences™.

- Step 2. Move your mouse to Programs.
- Step 3. Move your mouse to the right and over Descartes Omniserver vs 2.0.
- Step 4. Continue moving your mouse to the right until you find Omniserver Configuration.
- Step 5. Click on Omniserver Configuration. The Omniserver Configuration dialog box appears. (See Fig. 185)



FIG. 185: OMNISERVER CONFIGURATION DIALOG BOX

Step 6. Click on the File pull down menu. (See Fig. 186)



FIG. 186: OMNISERVER CONFIGURATION DIALOG BOX

- Step 7. Click on New.
- Step 8. Move the cursor to the right until the flyout menu appears.
- Step 9. Click on Winsock Device. (See Fig. 186) The Winsock Device Configuration dialog box appears. (See Fig. 187)

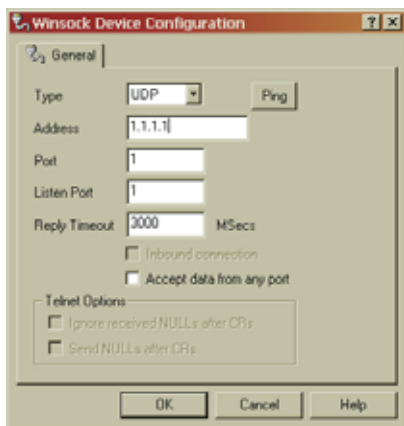

FIG. 187: WINSOCK DEVICE CONFIGURATION/DEFAULT PARAMETERS

- Step 10. If UDP is not selected, click on the Type pull down list. Click on UDP to select it. (See Fig. 188)



FIG. 188: WINSOCK CONFIGURATION/ENTERING HI 3000 SETUP PARAMETERS

- Step 11. Click in the Address text field. Type in the IP address of the HI 3000 device to which you want to connect. In our example we used 192.168.110.27 which is the IP address for an HI 3601 Machine Monitor.
- Step 12. Click in the Port text field. Enter the number "1024" without the quotation marks.
- Step 13. Click in the Listen Port text field. Enter the number "1024" without the quotations marks.
- Step 14. Click in the Reply Time out to select the tim (in milliseconds) you want to wait until the instrument replies. We selected 250 MSecs. Your application will require a different reply time.
- Step 15. If you want to see if the HI 3000 module is connected, click on the Ping button. If the instrument is connected you should receive messages back like the ones below: (See Fig. 189)

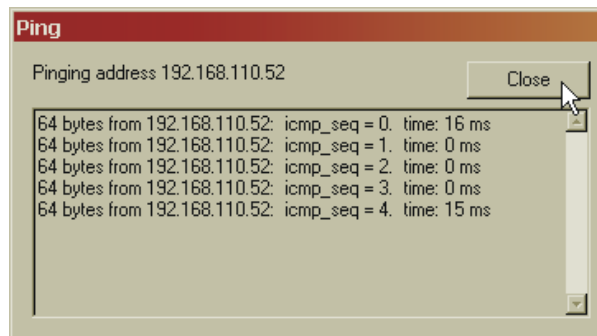

FIG. 189: PINGING HI 3000 MODULE/CONNECTION INDICATED

- Step 16. Click on the Close button.
- Step 17. Click on the OK button. An Icon appears with the IP address of the HI 3000 device you just connected to. (See Fig. 190)

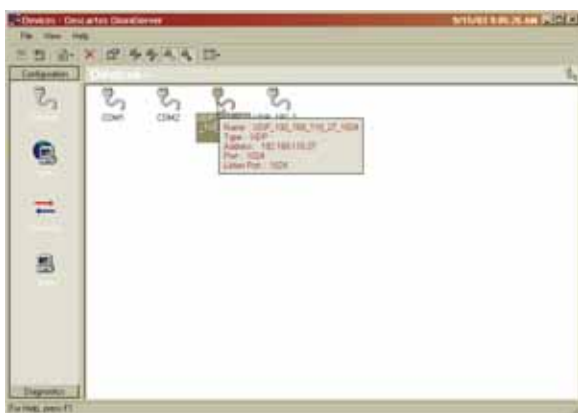

FIG. 190: HI 3000 DEVICE ICON WITH IP ADDRESS

Protocol Configuration

Step 1. Under Configuration, Click on the Protocols Icon. (See Fig. 190) The Protocols dialog box appears. (See Fig. 191)



FIG. 191: PROTOCOLS DIALOG BOX

Step 2. Click on the File pull down menu.
 Step 3. Click on New.
 Step 4. Slide the cursor to the right until the flyout menu appears. (See Fig. 191) Click on Protocols.
 Step 5. The Protocol Definition dialog box appears. (See Fig. 192)



FIG. 192: PROTOCOL DEFINITION/DOUBLE OR RIGHT CLICK ON PROTOCOL SETTINGS

Step 6. Double or Right Click on Protocol Settings. (See Fig. 192) The Protocol Definition dialog box appears. (See Fig. 193)

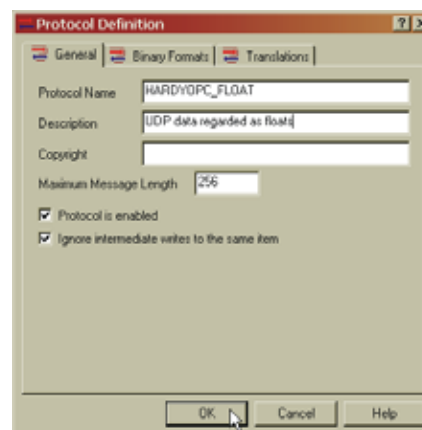

FIG. 193: PROTOCOLS DEFINITION DIALOG BOX/ CREATING PROTOCOL NAME AND DESCRIPTION

Step 7. In the Protocol Name text field, type in “HARDYOPC_FLOAT” without the quotation marks.
 Step 8. Click in the Description text field. Type in whatever you want to describe this protocol. We entered “UDP data regarded as floats!”.
 Step 9. If you want to change the Maximum Message Length, click in the Maximum Message Length text field. Type in the length of message you want. We entered “256”.
 Step 10. Click in the Protocol is enabled check box.
 Step 11. Click in Ignore intermediate writes to the same item check box.
 Step 12. Click on the Binary Formats tab. The Binary Format page appears. (See Fig. 194)

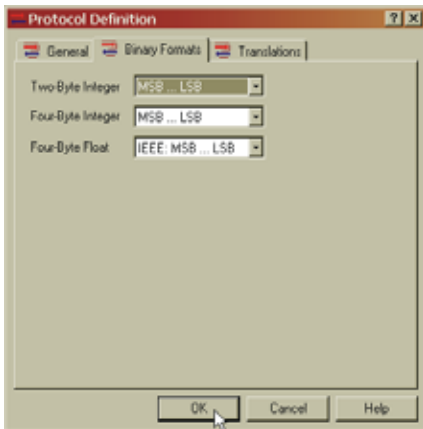

FIG. 194: PROTOCOL DEFINITION/BINARY FORMATS PAGE

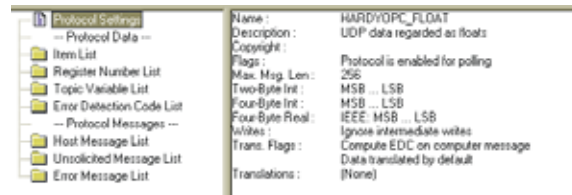

FIG. 196: PROTOCOL SETTINGS WITH NEW PROTOCOL DEFINITIONS

- Step 13. Click on the Two-Byte Integer pull down list. Click on “MSB...LSB”.
- Step 14. Click on the Four-Byte Integer pull down list.
- Step 15. Click on “MSB...LSB”.
- Step 16. Click on the “Four-Byte Float” pull down menu.
- Step 17. Click on “IEEE: MSB...LSB”.
- Step 18. Click on the Translations Tab. The Translations page appears. (See Fig. 195) There should be nothing in the text area. The two check boxes should be checked.

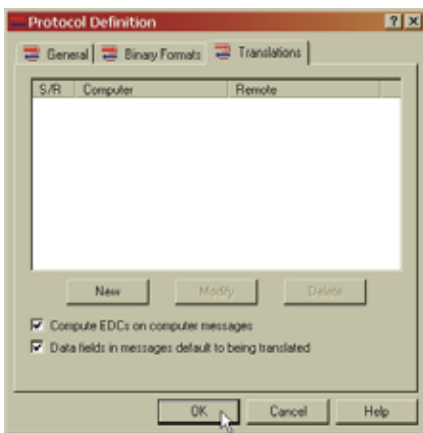

FIG. 195: PROTOCOLS DEFINITION

- Step 19. Click on the OK button to select the Protocol Definition parameters. The Protocol Settings with the new protocol definition appears. (See Fig. 196)

- Step 20. Click on the Topics Icon. (See Fig. 197) The Topics page appears. (See Fig. 198)

Topics Configuration



FIG. 197: SELECTING TOPICS ICON

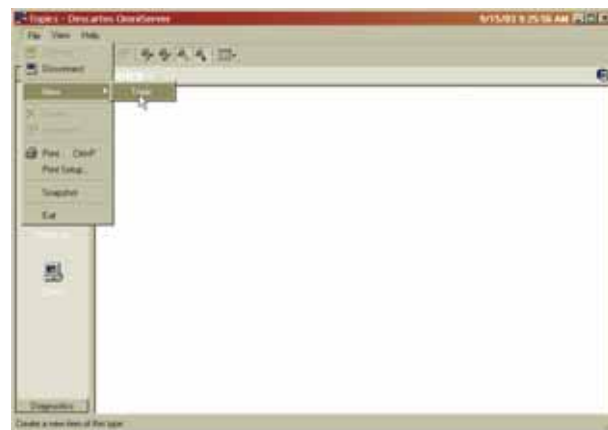
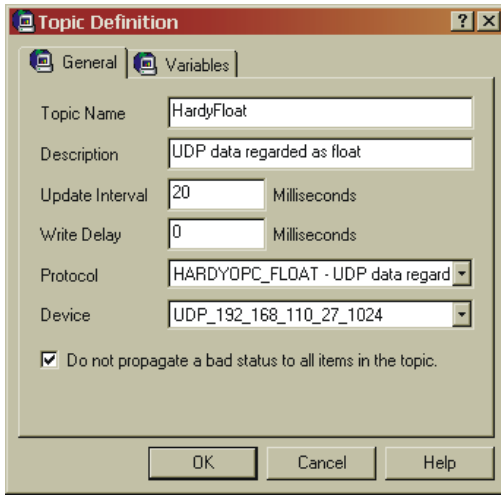

FIG. 198: TOPICS PAGE/SELECTING A NEW TOPIC

- Step 1. Click on the File pull down menu.
- Step 2. Click on New.
- Step 3. Move the cursor to the right until the fly out menu appears.

Step 4. Click on Topic. (See Fig. 198) The Topic Definition dialog box appears. (See Fig. 199)



**FIG. 199: TOPIC DEFINITION DIALOG BOX/
CREATING TOPIC DEFINITION**

Step 5. Click in the Topic Name text field. Enter a descriptive name for the Topic. In our example we entered HardyFloat.

NOTE: The topic name must be one word. Do not put spaces between the words.

Step 6. Click in the Description text field. Enter a descriptive name for the topic. We entered “UDP data regarded as float”.

Step 7. Click in the Update Interval text field. The Update interval is the amount of time between updates. In our example we selected 20 Milliseconds.

Step 8. Click in the Write Delay text field. Select the time you want a write to delay before writing to a file. In our example we selected 0 milliseconds.

Step 9. Click on the Protocol pull down list. Click on “HARDYOPC_FLOAT - UDP data regarded as float.”

Step 10. Click on the Device pull down list. Click on the IP Address of the device you are configuring. In our example the IP Address selected is:

- UDP_192_168_110_27_1024

Step 11. Click on the Variables tab. The Variables page appears. (See Fig. 200) The Variables Page should be empty.

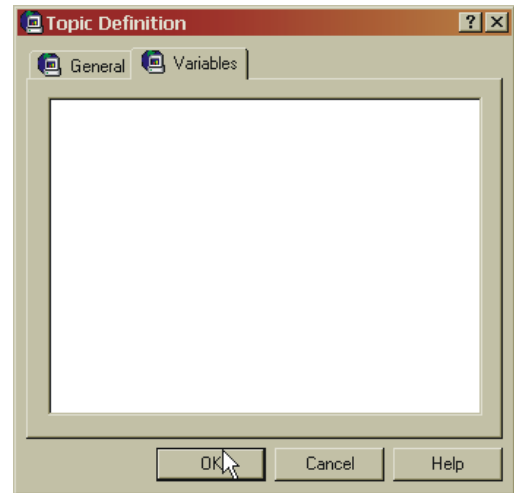

FIG. 200: TOPIC DEFINITION/VARIABLES PAGE

Step 12. Click on the OK button to select the Topic Definition parameters. A HardyFloat Topic Icon appears. (See Fig. 201)



FIG. 201: TOPIC DEFINITION/HARDYFLOAT ICON

Step 13. Click on the Protocols Icon again. The Protocol page appears. (See Fig. 202)

Step 14. Click once on HARDYOPC_FLOAT to high light the selection.

Step 15. Click on the File pull down menu.

Step 16. Click on New.

Step 17. Move the cursor to the right until the fly-out menu appears. (See Fig. 203)

Step 18. Click on Item. The Item Definition dialog box appears. (See Fig. 204)

Items Definition Setup



FIG. 202: PROTOCOL PAGE/HIGHLIGHTING HARDYOPC_FLOAT



FIG. 203: PROTOCOL PAGE/SELECTING NEW ITEM

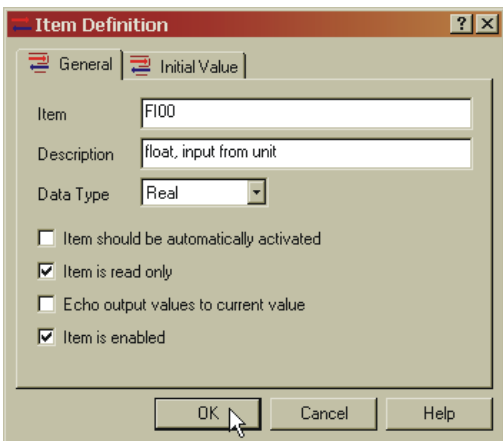

FIG. 204: ITEM DEFINITION DIALOG BOX

- Step 1. Click in the Item text field.
- Step 2. Enter "FI00" in the field. Float In 0.0 value.
- Step 3. Click in the Description text field.
- Step 4. Enter a description of the Item. In our example we entered "float, input from unit" without the quotation marks.

- Step 5. Click on the Data Type pull down menu.
- Step 6. Click on Real.
- Step 7. Click in the check box next to "Item is Read Only".
- Step 8. Click in the check box next to "Item is Enabled". There now should be a check in each box.
- Step 9. Click on the Initial Value tab.
- Step 10. The Initial Value page appears. (See Fig. 205)

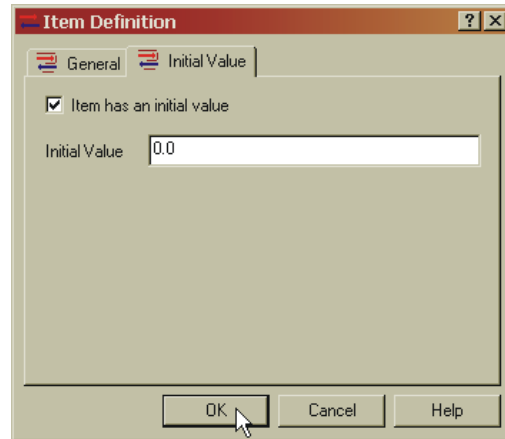

FIG. 205: ITEM DEFINITION

- Step 11. Click in the check box next to "Item has an initial value".
- Step 12. Click in the Initial Value text field and enter the initial value you want to use for this item. We entered 0.0 for Item FI00.
- Step 13. Click on the OK button to select the item definition.
- Step 14. Click on the File pull down menu.
- Step 15. Click on New.
- Step 16. Continue the item definition process until you have entered all the items (FI00...FI62).
- Step 17. Move the cursor to the right until Item appears.
- Step 18. Click on Item. The Item Definition dialog box appears. (See Fig. 206)

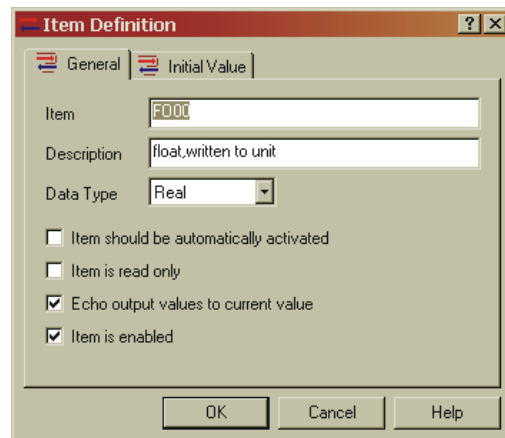

FIG. 206: ITEM DEFINITION/ENTERING F000

Step 19. Click in the Item text field.

Step 20. This time enter “FO00”.

NOTE: The first O is the letter O. The second and third O's are the number zero “0”. Be careful not to mix them up. You must also enter a two digit value.

Step 21. Enter a description of the Item. In our example we entered “float, written to unit” without the quotation marks.

Step 22. Click on the Data Type pull down menu.

Step 23. Click on Real.

Step 24. Click in the check box next to “Item is Read Only”.

Step 25. Click in the check box next to “Item is Enabled”.

There now should be a check in each box.

Step 26. Click on the Initial Value tab.

Step 27. The Initial Value page appears. (See Fig. 207)

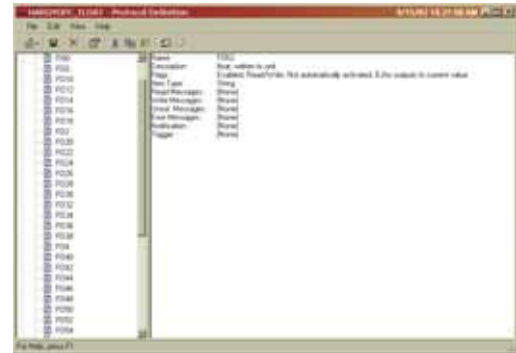

FIG. 208: PROTOCOL PAGE/ITEM LIST ENTERED

Step 32. Repeat the Item Definition three more times and enter the information in Figs. 209, 210, 211.

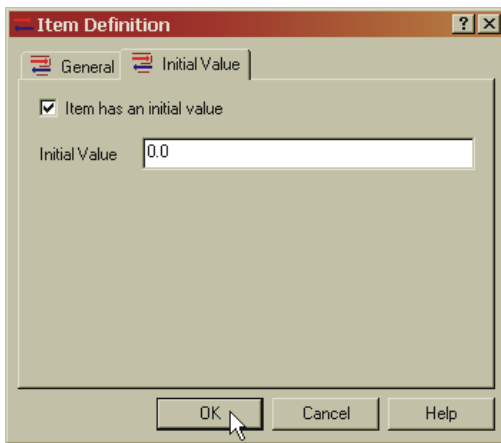

FIG. 207: ITEM DEFINITION

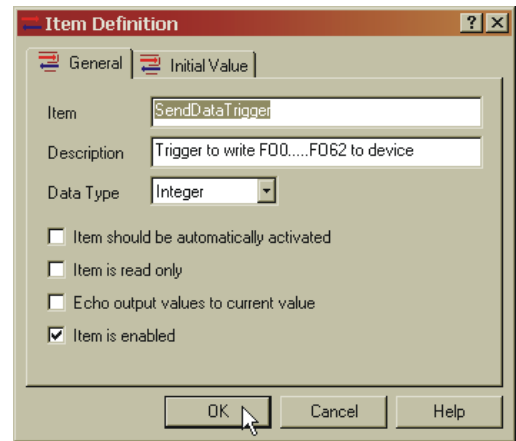

FIG. 209: ITEM DEFINITION/SEND DATA TRIGGER

Step 28. Click in the check box next to “Item has an initial value”.

Step 29. Click in the Initial Value text field and enter the initial value you want to use for this item. We entered 0.0 for Item FO00.

Step 30. Click on the OK button to select the item definition.

Step 31. Continue the item definition process until you have entered all the items (FO00...FO62). (See Fig. 208)

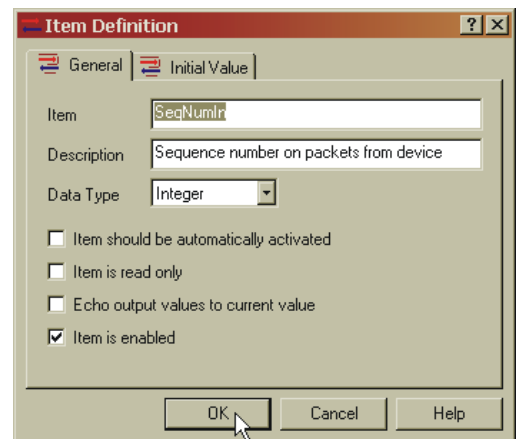

FIG. 210: ITEM DEFINITION/SEQUENCE NUMBER IN

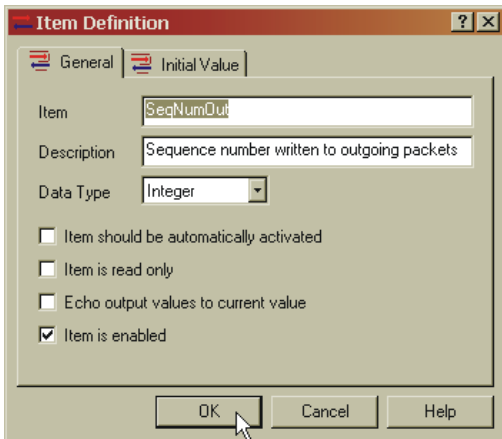

FIG. 211: ITEM DEFINITION/SEQUENCE NUMBER OUT

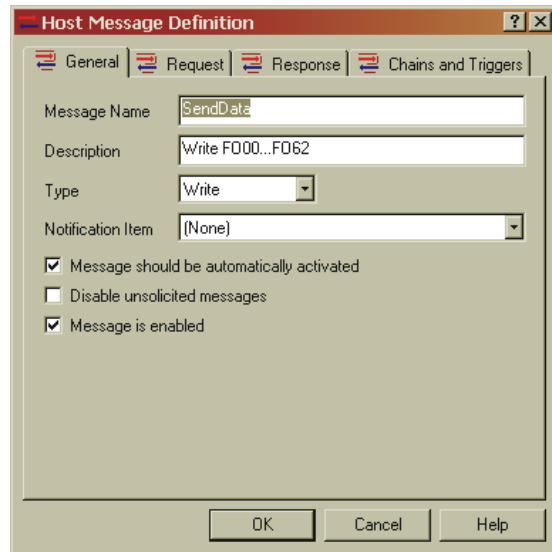

FIG. 213: HOST MESSAGE DEFINITION

- Step 33. Click on File.
- Step 34. Click on New.
- Step 35. Click on Host Message (See Fig. 212) The Host Message Definition page appears. (See Fig. 213)

- Step 1. With the General tab selected, click in the Message Name text field.
- Step 2. Enter "SendData" (all one word) without the quotation marks.
- Step 3. Click in the Definition text field.
- Step 4. Enter "Write FO00...FO62" without the quotation marks.
- Step 5. Click on the Type pull down menu.
- Step 6. Click on Write.
- Step 7. Make sure that the check boxes are checked for "Message should be automatically activated" and "Message is enabled."
- Step 8. Click on the Request tab. The Request page appears with nothing entered in the text field. (See Fig. 214)



FIG. 212: PROTOCOL PAGE/SELECTING HOST MESSAGE

Host Message Configuration

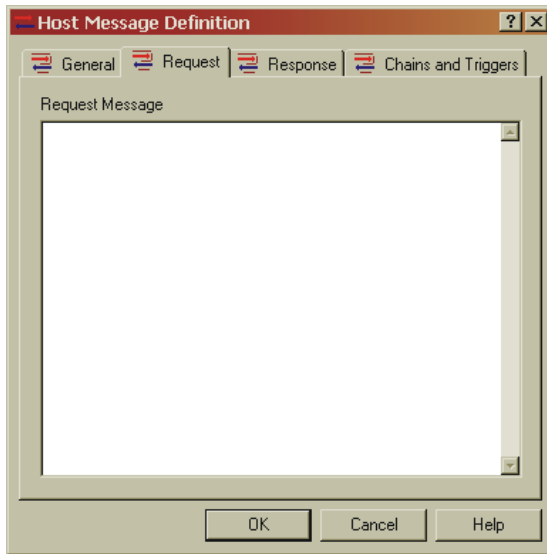

FIG. 214: REQUEST PAGE WITH NO REQUEST MESSAGE

Step 9. On the Documentation CD that you received with your instrument, you will see two (2) OPC DPD files, “OPCFloat DPD” & “OPCMiscellaneous DPD”. When retrofitting or in the event you do not have the HI 3000 Resource CD, do the following:

- From the Web Page click on the www Link, HI 3000 Series Support Site. (See Fig. 215) The Support Site Web Page appears. (See Fig. 216)



FIG. 215: SELECTING WWW LINK



FIG. 216: HI 3000 SUPPORT SITE

- Click on HI 3000 Series Downloads. The Downloads Page appears.
- Next to EPS Downloads, click on OPC Float DPD. (See Fig. 217) The File Download dialog box appears. (See Fig. 218)



FIG. 217: EPS FILES/SELECTING OPC FLOAT DPD FILE

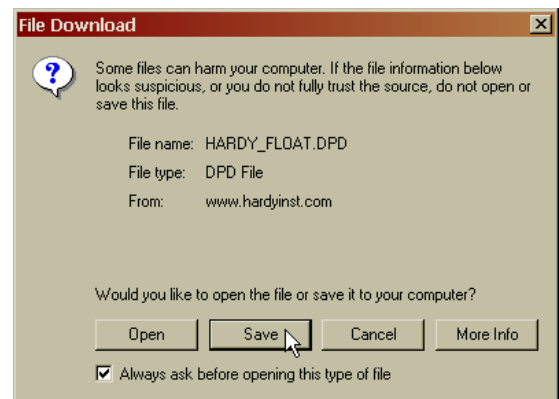

FIG. 218: FILE DOWNLOAD DIALOG BOX

Step 10. Click on the Save button. (See Fig. 218) The “Save As” dialog box appears. (See Fig. 219)

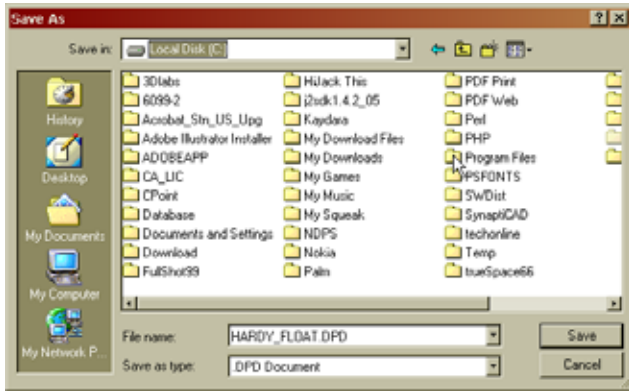

FIG. 219: SAVE AS DIALOG BOX/SELECTING PROGRAM FILES

Step 11. Double click on “Program Files”. The Program Files folder list appears. (See Fig. 220)

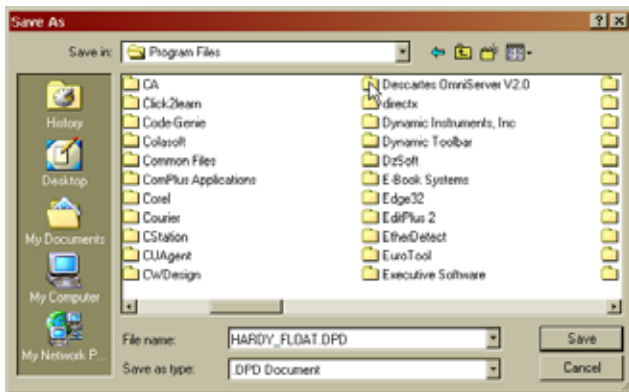

FIG. 220: PROGRAM FILES/SELECTING DESCARTES OMNISERVER

Step 12. Double click on Descartes Omnserver V2.0. The Descartes Omnserver folder opens. (See Fig. 221)

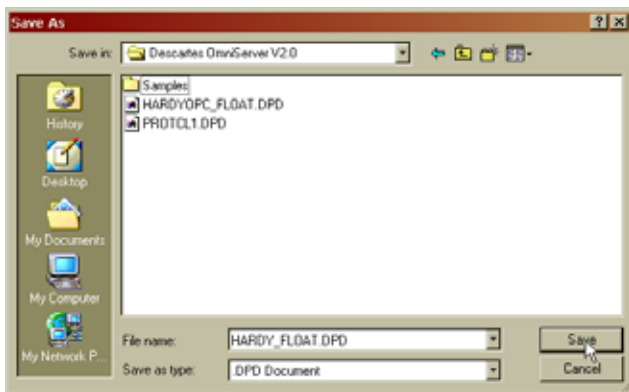

FIG. 221: OMNISERVER FOLDER SAVING DPD FILE

Step 13. Save the DPD file in the Omniserver folder. **DO NOT** make a special folder for the .dpd files.

Step 14. Repeat the process for the “OPCMiscellaneous DPD” file.

Step 15. When you open the Omniserver application the Host Message is already configured for you.

Step 16. If you do not have access to the DPD files, click in the text field and enter the following information. (See Fig. 222)

- {0:2UB}
 {FO00:RB}{FO02:RB}{FO04:RB}{FO06:RB}
 {FO08:RB}{FO10:RB}{FO12:RB}{FO14:RB}
 {FO16:RB}{FO18:RB}{FO20:RB}{FO22:RB}
 {FO24:RB}{FO26:RB}{FO28:RB}{FO30:RB}
 {FO32:RB}{FO34:RB}{FO36:RB}{FO38:RB}
 {FO40:RB}{FO42:RB}{FO44:RB}{FO46:RB}
 {FO48:RB}{FO50:RB}{FO52:RB}{FO54:RB}
 {FO56:RB}{FO58:RB}{FO60:RB}{FO62:RB}
 {SeqNumOut:4UB}

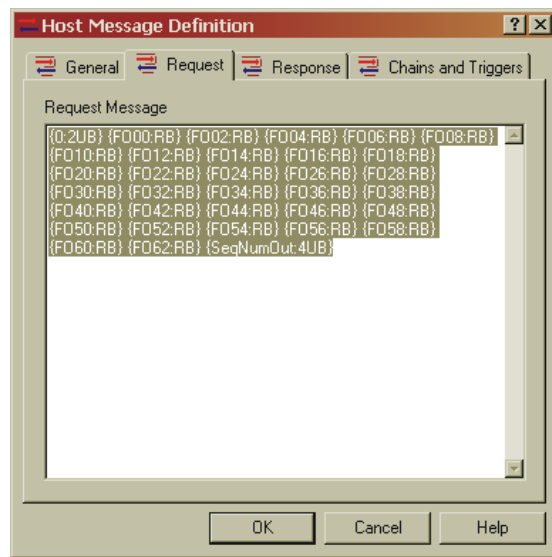

FIG. 222: HOST MESSAGE

NOTE: Everything must be correct in the Host Message or the server will not work properly.

Step 17. Click on the Chains and Triggers tab. (See Fig. 222) The Chains and Triggers page appears. (See Fig. 223)

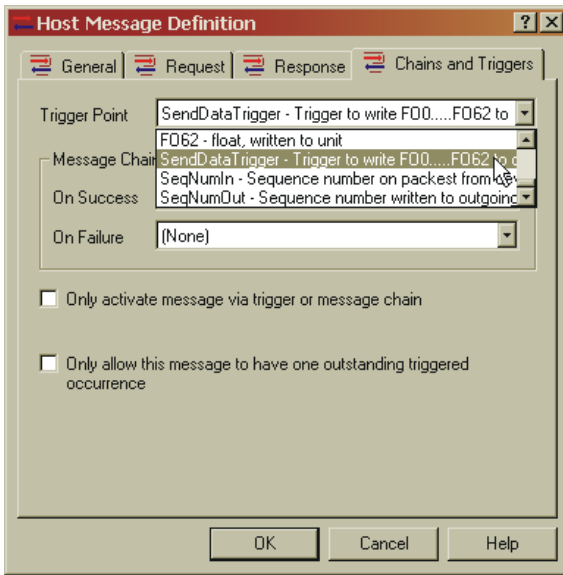

FIG. 223: CHAINS AND TRIGGERS PAGE

- Step 18. Click on the Trigger Point pull down list.
- Step 19. Click on “SendDataTrigger - Trigger to write FO0...FO62 to” to select this Trigger Point (See Fig. 223)
- Step 20. Click on the OK button to save the selections.

Unsolicited Message Definition

- Step 1. Click on Unsolicited Messages. (See Fig. 224) The Unsolicited Message Definition dialog box appears. (See Fig. 225)



FIG. 224: PROTOCOL DEFINITION/SELECTING UNSOLICITED MESSAGES

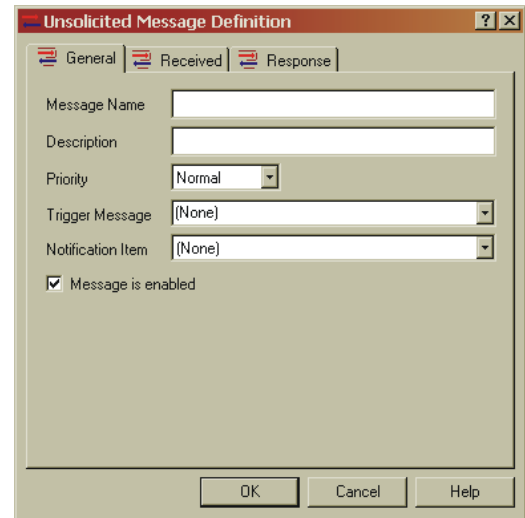

FIG. 225: UNSOLICITED MESSAGE DEFINITION PAGE

- Step 2. Click in the Message Name text field.
- Step 3. Enter “UDP_DATA”.
- Step 4. Click in the Description text field.
- Step 5. Enter “UDP data, received from device” (See Fig. 226)

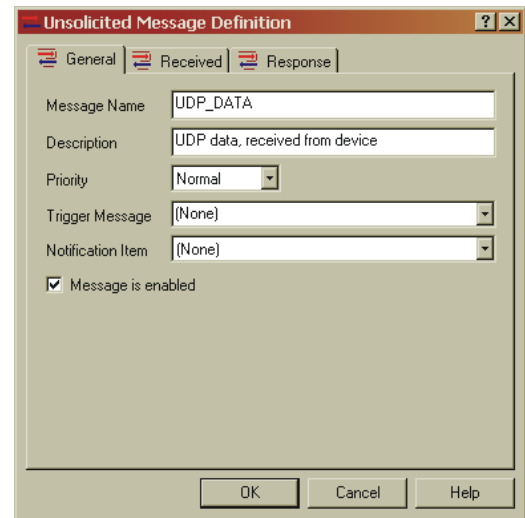
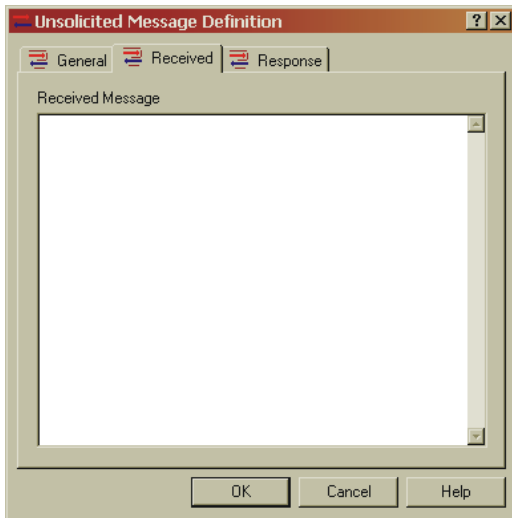
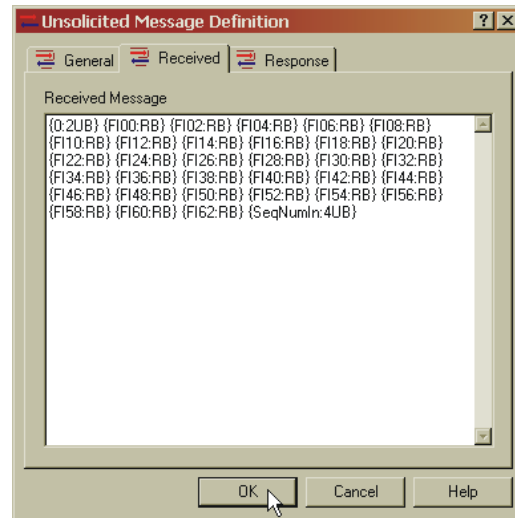

FIG. 226: UNSOLICITED MESSAGE DEFINITION/ NAME AND DESCRIPTION ENTERED

- Step 6. Click on the Received Tab. The Received page appears. (See Fig. 227)



**FIG. 227: UNSOLICITED MESSAGE DEFINITION/
RECEIVED PAGE**



**FIG. 228: UNSOLICITED MESSAGE DEFINITION/
RECEIVED MESSAGE**

Step 7. Click in the text field and enter the following information: (See Fig. 227)

- On the Information CD that you received with your instrument, you should have two (2) OPC DPD files. Make sure that you have copied these DPD files into the Descartes Omniserver folder as described above. If you don't see the information in the text field download the files from the Web Site Download section. See downloading instructions from the Configuration of Host Message above.
- If you do not have access to the Web Site Download or the CD then copy the information below into the Received Message text field. (See Fig. 278)

```
{0:2UB}
{FI00:4RB}{FI02:4RB}{FI04:4RB}{FI06:4RB}{FI08:4R
B}{FI10:4RB}{FI12:4RB}{FI14:4RB}{FI16:4RB}{FI18:4
RB}{FI20:4RB}{FI22:4RB}{FI24:4RB}{FI26:4RB}{FI28:
4RB}{FI30:4RB}{FI32:4RB}{FI34:4RB}{FI36:4RB}{FI3
8:4RB}{FI40:4RB}{FI42:4RB}{FI44:4RB}{FI46:4RB}{FI
48:4RB}{FI50:4RB}{FI52:4RB}{FI54:4RB}{FI56:4RB}{
FI58:4RB}{FI60:4RB}{FI62:4RB}{SeqNumIn:4UB}
```

Step 8. Click on the OK button to save the configuration. (See Fig. 228)

Setting Up OPC Communication with a Client

About OPC Clients

There are several versions of OPC Clients on the market today. We can't possibly provide instructions for every client however the setup is pretty much the same. We have selected Wonderware® for our tutorial. Wonderware® is the most popular Factory Suite software currently on the market. If you are looking for another OPC Client, we recommend going to the OPC Foundation Web Site and checking their list of certified products. In addition, on the OPC Foundation Site there is ample information about the OPC protocol to answer any questions you may have that are beyond the scope of this manual.

NOTE: Wonderware® is a registered trademark of the Naiveness Corporation.

Step 1. If you haven't installed Wonderware InTouch, install it now.

NOTE: Windows® 2000, Service Pak 3 or Windows® XP Service Pak 1 are required. Windows® is a registered trademark of the Microsoft Corporation.

Step 2. Start the OPC Server (Omniserver™) from your PC desktop. The OPC Server must be running when configuring Wonderware.

- Step 3. Open Wonderware WWClient. (See Fig. 229)
WWClient dialog box appears with the logviewer dialog box open. (See Fig. 230)

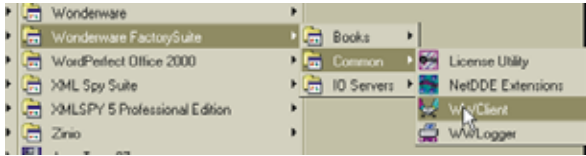

FIG. 229: WONDERWARE/SELECTING WWCLIENT

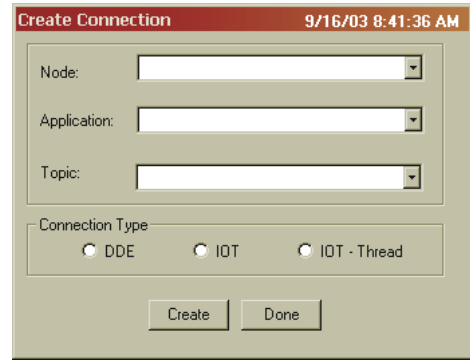

FIG. 232: CREATE CONNECTION DIALOG BOX

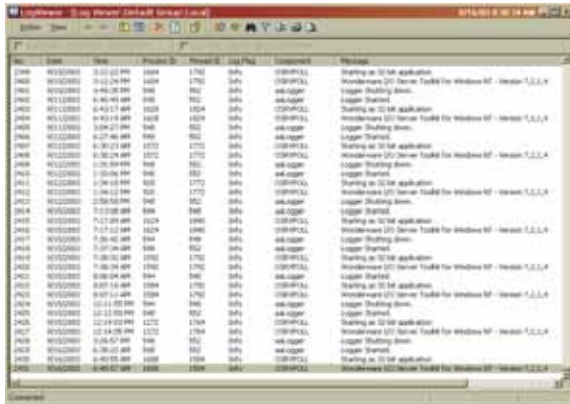

FIG. 230: WONDERWARE/CLOSE THE LOG VIEWER

- Step 7. Click in the Application text field.
Step 8. Enter the following: “osrvpoll” without the quotation marks.
Step 9. Click in the Topic text field. Enter the Topic name you assigned to the unit to which you are connected. In our example we used “HardyFloat”.
Step 10. Click in the radio button next to IOT (this is the Suitelink connection)
Step 11. Click on the Create button. (See Fig. 233) In the WWClient page an IOT connection entry appears. (See Fig. 234)

- Step 4. Close the Logviewer Dialog box.
Step 5. Click on the Connections pull down menu. (See Fig. 231)



FIG. 231: WWCLIENT/SELECTING CREATE CONNECTION

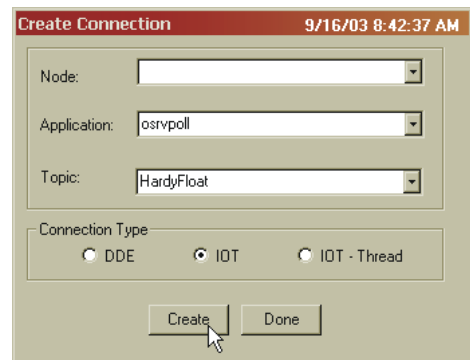

FIG. 233: CREATE CONNECTION DIALOG BOX

- Step 6. Click on Create. The Create Connection dialog box appears. (See Fig. 232)

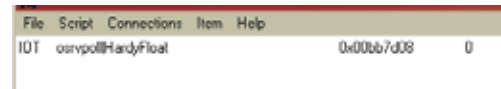

FIG. 234: IOT CONNECTION

- Step 12. Click on the Item in the menu list. The Item dialog box appears with the connection listed. (See Fig. 235)

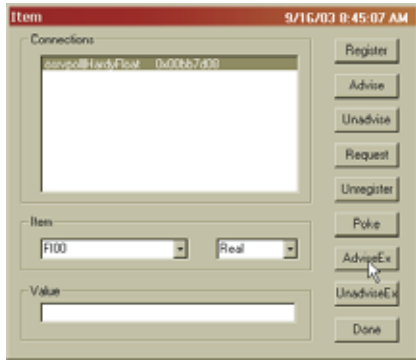

FIG. 235: ITEM DIALOG BOX

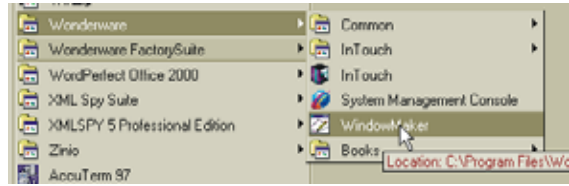

FIG. 238: WONDERWARE/OPENING WINDOWMAKER

Step 19. The Windows to Open dialog box appears with the Windows to Open dialog box displayed. (See Fig. 239)

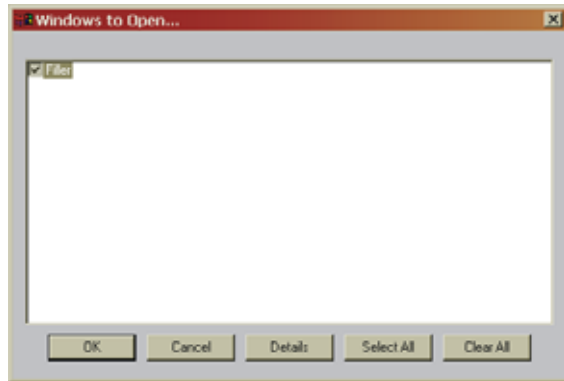

FIG. 239: WINDOWMAKER DIALOG BOX

- Step 13. Click on the Item pull down list. Select the item from the list, or type the address of one of the items you created when setting up the Protocol Item List in Omniserver. In our example we selected FI00.
- Step 14. Click on the pull down list to the right and select Real.
- Step 15. Click on the AdviseEx button.
- Step 16. Repeat this process for other items you may want to use. They appear in the WWClient table of items, under the Connection listing. (See Fig. 236 & 237)



FIG. 236: WWCLIENT/LIST OF IOT CONNECTIONS



FIG. 237: WWCLIENT/LIST OF ITEMS (FI00)

- Step 17. Close WWClient.
- Step 18. Open Wonderware WindowMaker. (See Fig. 238)

- Step 20. Close the “Windows to Open” dialog box by clicking on Cancel.
- Step 21. Click on the File pull down menu.
- Step 22. Click on New Window. The “Window Properties” dialog box appears. (See Fig. 240)

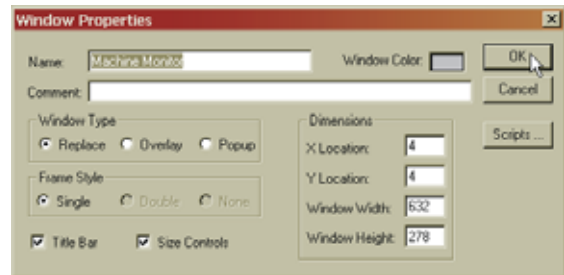

FIG. 240: WINDOWMAKER/OPENING A NEW WINDOW

- Step 23. Click in the Name text field. Enter a name that describes the instrument or parameter you are monitoring. In our example we entered Machine Monitor for the HI 3600 Machine Monitor instrument.

Step 24. If you want to select a different color do so at this time.

Step 25. Click on the OK button. A new window appears. (See Fig. 241)

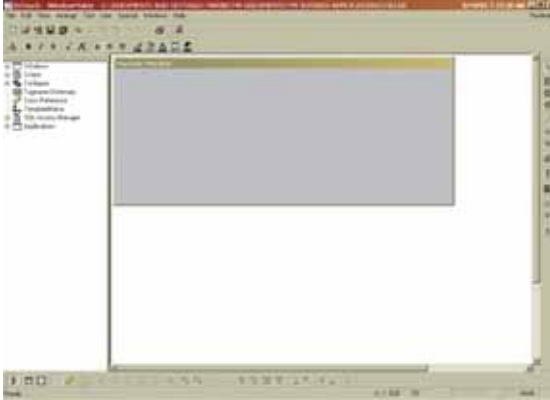

FIG. 241: WINDOW MAKER/CREATING A NEW WINDOW

Step 26. Click on the Text tool. This is the Tool with the uppercase T on the right hand side of the display.

Step 27. Click anywhere on the window. Enter a series of number symbols (i.e. ###.####) (See Fig. 242)



FIG. 242: MACHINE MONITOR WINDOW ENTERING ###.####

Step 28. Place the cursor over the text entry (###.####) and right click the mouse. A list of functions appear. (See Fig. 243)

Step 29. Click on Animation Links. The Object Type dialog box appears. (See Fig. 244)

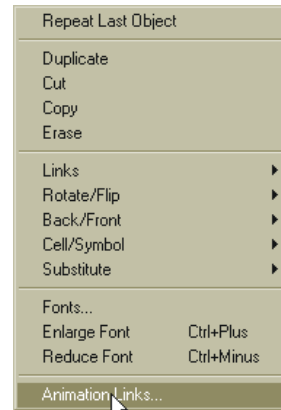

FIG. 243: WINDOWMAKER/SELECTING ANIMATION LINKS

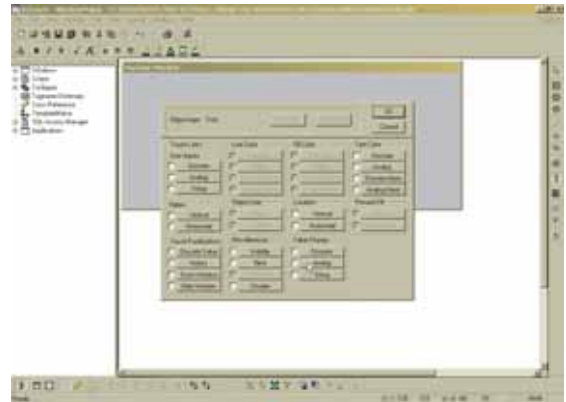

FIG. 244: WINDOWMAKER/OBJECT TYPE DIALOG BOX

Step 30. In the Value Display section, click on the radio button next to Analog.

Step 31. Click on the Analog button. The Access Names dialog box appears. (See Fig. 245)

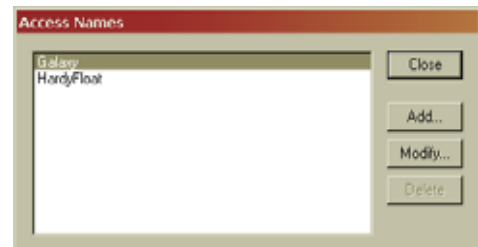

FIG. 245: WINDOWMAKER/ACCESS NAME DIALOG BOX

Step 32. Click on the Add... button. The Add Access Names dialog box appears. (See Fig. 246)

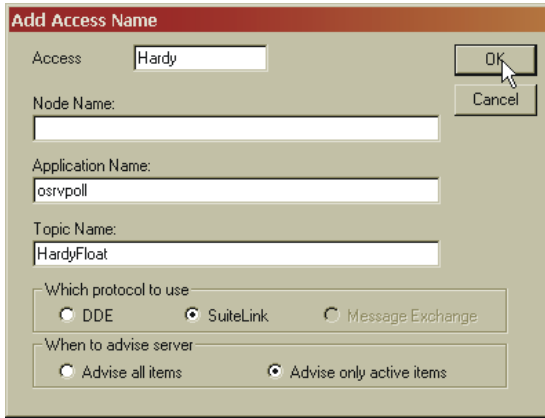

FIG. 246: WINDOWMAKER/ADD ACCESS NAME DIALOG BOX

- Step 33. Click in the Access text field. Type in an Access name of your choosing. We selected Hardy.
- Step 34. Click in the Application Name text field. Enter “osrvpoll” without the quotation marks.
- Step 35. Click in the Topic Name text field. Enter the Topic Name you assigned in the Omniserver. We assigned the name “HardyFloat”.
- Step 36. Click in the radio button next to SuiteLink.
- Step 37. Click in the radio button next to Advise only active items.
- Step 38. Click on the OK button.
- Step 39. Click on Tagname Dictionary. (See Fig. 247) The Tagname Dictionary dialog box appears. (See Fig. 248)

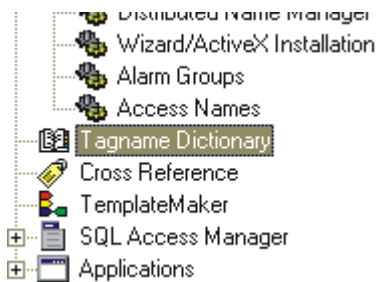

FIG. 247: WINDOWMAKER/SELECTING TAGNAME DICTIONARY

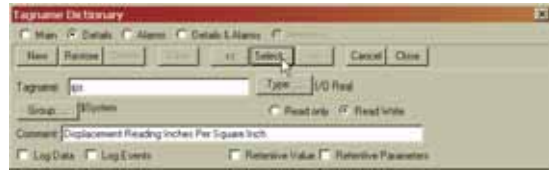

FIG. 248: WINDOWMAKER/CREATING A TAG NAME

- Step 40. Click on Select. The Select Tag dialog box appears. (See Fig. 249)

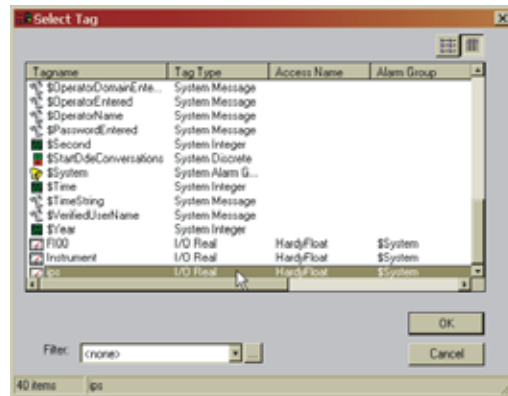

FIG. 249: WINDOWMAKER/SELECT TAG DIALOG BOX/SELECTING IPS

- Step 41. Click on the tag you want to use for this item. We selected “ips”.
- Step 42. Click on the OK button.
- Step 43. Click on the Close button in the Creating a Name dialog box.
- Step 44. If you are creating a tag name for the first time do the following:

- Click in the Tagname text field.
- Enter a Tag name.
- Click in the Comments text field. Enter a description of the Tag.
- Make sure the Details radio button is selected.
- Click on the New button to add this tag name to the Tagname list.

- Step 45. You are now back to the newly created Window. (See Fig. 250)



FIG. 250: NEWLY CREATED WINDOW

Step 46. In the upper right hand corner of the screen you will find “Runtime”. (See Fig. 251) Click on “Runtime”. The window becomes active and a value (1.0000) replaces the “###.####”. (See Fig. 252) This value is the status of Channel 1, Card Slot 3 on a HI 3600 that is communicating to the Omniserver and ultimately to the Wonderware window. In this case 1.000 means that the Channel is OK. If there was a value of 2.000 the Channel is not OK. You are up and running.

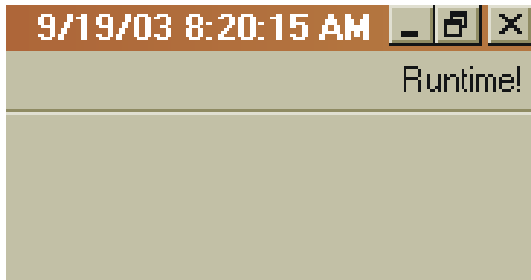

FIG. 251: WINDOWMAKER/SELECTING RUNTIME



FIG. 252: WINDOWMAKER/RUNTIME VALUE

Step 47. If there are any further Wonderware or Omniserver features, setups, or parameters you want to use, please consult the User Guides for the respective product.

Setting up the Output to the OPC Server and the Client from the HI 3000 Module

Now that there is communication between the HI 3000 Module the OPC Server and the Client we can map the informa-

tion you want to the Server Output Item table (FO00....FO62). First you need to set up Hardy Control Link (Ethernet TCP/IP).

Adding the HI 3000 Module to the Hardy Control-Link (TCP/IP) Network

Step 1. From the HI 3000 instrument Main Page, click on Configuration. (See Fig. 253) The Configuration page appears. (See Fig. 254)



FIG. 253: HI 3030 MAIN WEB PAGE/SELECTING CONFIGURATION



FIG. 254: CONFIGURATION PAGE/SELECTING HARDY CONTROL LINK

Step 2. Click on Hardy Control Link. The Configuration-Hardy Control-Link page appears. (See Fig. 255)

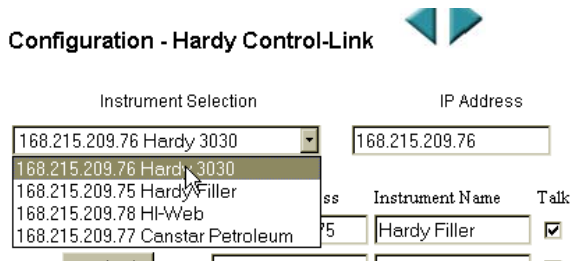

FIG. 255: HARDY CONTROL-LINK PAGE/ SELECTING LISTED HI 3000 MODULE IP ADDRESS

- Step 3. Click on the pull down list below Instrument Selection.
- Step 4. Click on the IP address of the instrument you are mapping. The IP address appears in the IP Address text field.
- Step 5. If you do not find the IP address of the instrument you going to configure, type the IP address of the instrument in the IP Address text field. In our example we typed "168.266.110.35". (See Fig. 256)
- Step 6. To assign the IP address to a Node you need to click on the Node button you selected for this instrument. In our example we selected Node 5. You can set up to 16 Nodes on the Hardy Control-Link Network.
- Step 7. Click on the Node 5 button. The IP address you selected from the list or the IP address you typed in the IP Address text field appears next to the Node 5 button. (See Fig. 257)
- Step 8. Click in the Instrument Name text field next to the Node 5 IP Address. Type in a descriptive name for the Instrument you are configuring.
- Step 9. If there is no check mark in the Talk Check Box to the right of the Node Address, click in the Check Box. A Check Mark appears. (See Fig. 257)

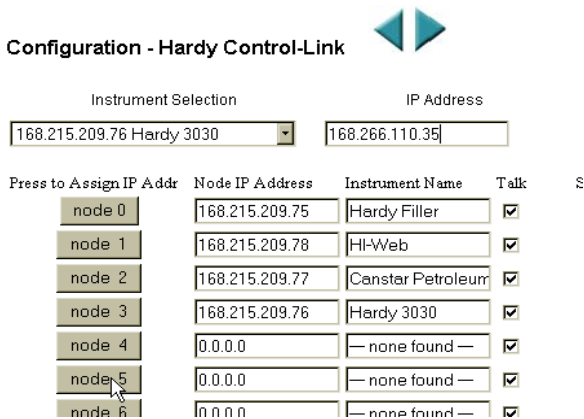

FIG. 256: HARDY CONTROL-LINK PAGE SELECTING NODE 5



FIG. 257: SELECTED INSTRUMENT'S IP ADDRESS APPEARS IN THE NODE 5 TEXT FIELD

- Step 10. Click on the Save Settings button located at the bottom of the node address list. (See Fig. 258) An OK? message box appears. (See Fig. 259)

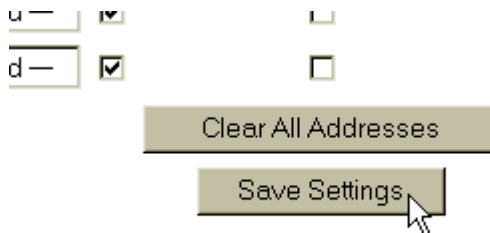

FIG. 258: SAVING THE NODE ADDRESS ASSIGNMENT



FIG. 259: OK MESSAGE BOX

- Step 11. Click on the OK button if you are satisfied with your entry. The IP Address of the instrument you want to configure permanently appears in the Node IP Address field. (See Fig. 260) The instrument has a Node 5 address in the network until you change it to another node or delete the node address.
- Step 12. If you are not satisfied or want to change something in the configuration, click on Cancel.

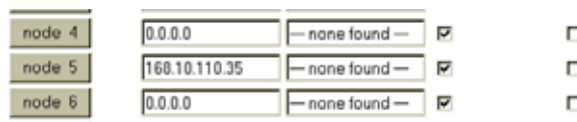

FIG. 260: NODE IP ADDRESS CONFIGURED

Step 13. To remove the instrument from the list. Enter 0.0.0.0 in the IP Address field and click on the Node button you want to reconfigure.

Mapping Parameters to the HardyFloat Output Table

Here are a few examples of mapped outputs to illustrate the mapping procedures:

Step 1. Make a table of the sources you want to map.

Index #	Source
0	Gross Weight Channel 1
2	Net Weight Channel 1
4	Gross Weight Channel 2
6	Net Weight Channel 2

NOTE: Do you remember the Index Numbers in the Host Message we set up when configuring the OPC Server? The Index numbers in the table correspond to those Index numbers. It is important to note that every Item in the OPC Server Host Message consists of two words.

Step 2. From the Main Web Page click on Configuration. The Configuration Page appears. (See Fig. 261)

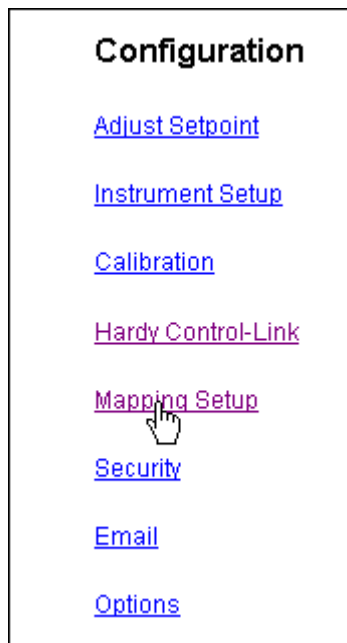

FIG. 261: CONFIGURATION PAGE/SELECTING MAPPING SETUP

Step 3. Click on “Mapping Setup”. “The Mapping Setup 1” Page appears. (See Fig. 262)

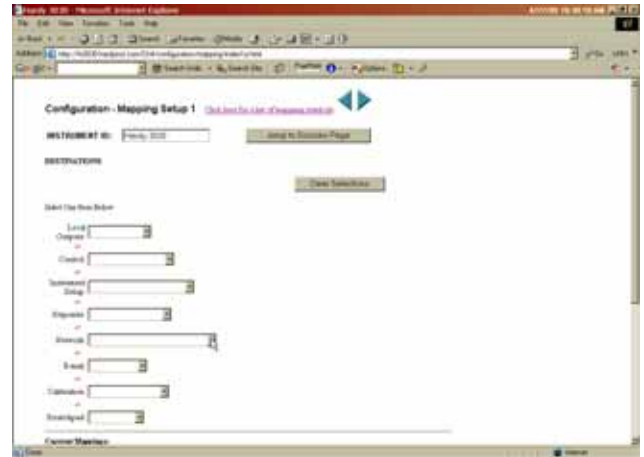

FIG. 262: MAPPING SETUP PAGE 1

Step 4. Click on the Network Pull Down List. (See Fig. 263)

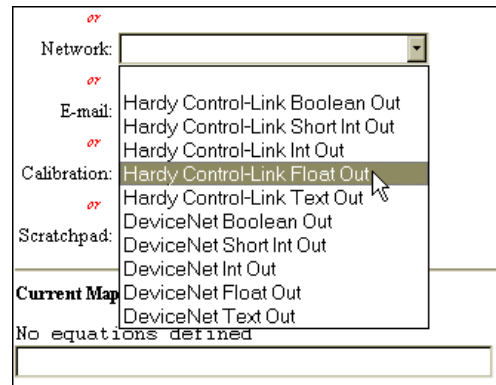

FIG. 263: MAPPING SETUP PAGE 1/SELECTING HARDY CONTROL-LINK FLOAT OUT

Step 5. Click on Hardy Control-Link Float Out. Hardy Control-Link float Out appears in the Network field with a Word and text field containing a “0”. It is important to note that every Item in the OPC Server Host Message consists of two words.



FIG. 264: HARDY CONTROL-LINK FLOAT OUT SELECTED/WORD 0

Step 6. In this case Word 0 is what we want. Click on the Select button to set the Destination. “EFO0”

appears in the Current Mappings text field. (See Fig. 265)



FIG. 265: HARDY CONTROL-LINK FLOAT OUT/WORD 0 (EFO0) SET AS MAPPING DESTINATION

Step 7. Click on the “Jump to Source Page” button. The Mapping Setup Page 2 Appears. (See Fig. 266)

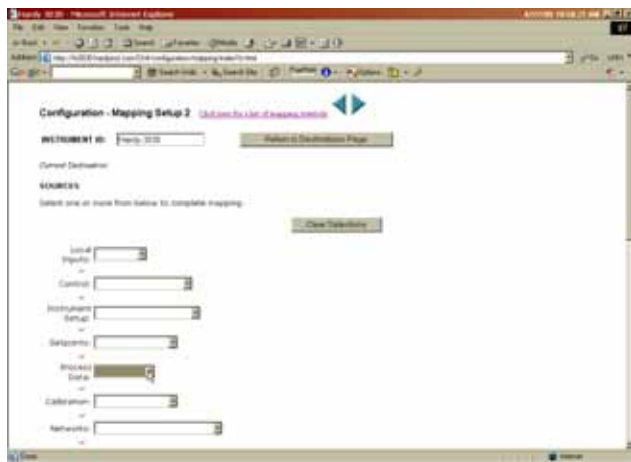

FIG. 266: MAPPING SETUP 2/SOURCE SELECTION PAGE

Step 8. Click on the Process Data Pull Down List. (See Fig. 267)

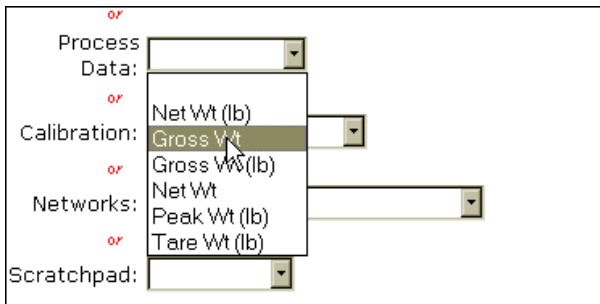

FIG. 267: MAPPING SETUP 2/SELECTING PROCESS DATA/GROSS WEIGHT

Step 9. Click on Gross Weight. (See Fig. 267) Gross Wt appears in the Process Data field with a Chan field containing the number 1 which is the channel we want.



FIG. 268: PROCESS DATA/GROSS WEIGHT CHANNEL 1 (HF14)

Step 10. Click on the Select button. “HF14” appears to the right of the assignment equals sign.



FIG. 269: GROSS WEIGHT-CHANNEL 1 ASSIGNED TO HARDY CONTROL-LINK FLOAT OUT

Step 11. Click on the Map button to map the assignment statement. (See Fig. 269)



FIG. 270: GROSS WEIGHT ASSIGNED TO HARDY CONTROL-LINK FLOAT OUT

Step 12. Click on the left arrow to return to Page 1.

Step 13. Click on the Network pull down list and select Hardy Control-Link Float Out again.

Step 14. This time type the number “2” in the Word field. (See Fig. 271)

NOTE: Remember the Items in the Host Message on the OPC Server consist of two words.



FIG. 271: HARDY CONTROL-LINK FLOAT OUT/WORD 2

Step 15. Click on the Select button. Hardy Control-Link Float Out Word 2 (EFO2) appears in the Current Mappings field. (See Fig. 272)



FIG. 272: HARDY CONTROL-LINK FLOAT OUT/WORD 2 SELECTED AS DESTINATION

- Step 16. Click on the “Jump to Sources Page” button. Mapping Setup 2 appears.
- Step 17. Click on the Process Data pull down list. (See Fig. 273)

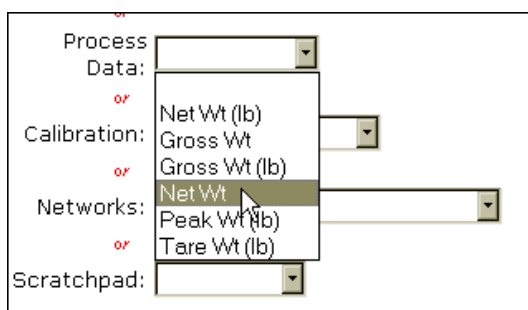

FIG. 273: MAPPING PAGE 2 SELECTING NET WEIGHT

- Step 18. Click on Net Wt. Net Wt appears in the Process Data field with Chan 1 to the right. (See Fig. 274)



FIG. 274: PROCESS DATA/SELECTING NET WEIGHT/CHANNEL 1

- Step 19. Click on the Select button. Net Weight/Channel 1 (HF18) appears in the Current Mappings field to the right of the Hardy Control-Link Float Out selection (EFO2).

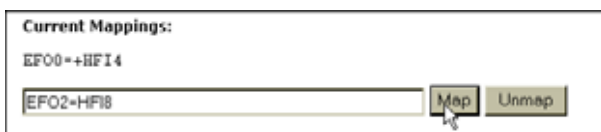

FIG. 275: CURRENT MAPPINGS/NET WEIGHT/CHANNEL 1 (HF18) ASSIGNED TO HARDY CONTROL-LINK FLOAT OUT (EFO2)

- Step 20. Click on the Map button to map the assignment statement. (See Fig. 275)

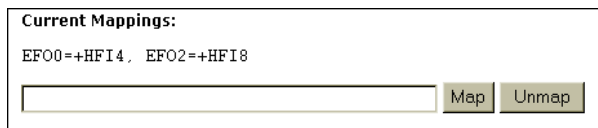

FIG. 276: NET WEIGHT ASSIGNED TO HARDY CONTROL-LINK FLOAT OUT

- Step 21. Click on the left arrow to return to Page 1.
- Step 22. Click on the Network pull down list and select Hardy Control-Link Float Out again.
- Step 23. This time type the number “4” in the Word field. (See Fig. 277)

NOTE: Remember the Items in the Host Message on the OPC Server consist of two words.



FIG. 277: HARDY CONTROL-LINK FLOAT OUT/WORD 4

- Step 24. Click on the Select button. Hardy Control-Link Float Out Word 2 (EFO4) appears in the Current Mappings field.



FIG. 278: HARDY CONTROL-LINK FLOAT OUT/WORD 4 SELECTED AS DESTINATION

- Step 25. Click on the “Jump to Sources Page” button. Mapping Setup 2 appears.
- Step 26. Click on the Process Data pull down list. (See Fig. 279)

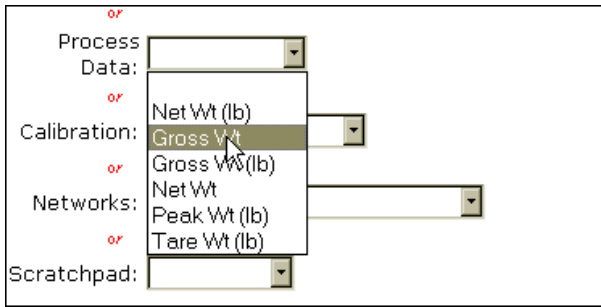

FIG. 279: MAPPING PAGE 2 SELECTING GROSS WEIGHT

Step 27. Click on Gross Wt. Gross Wt appears in the Process Data field with Chan 1 to the right. Click in the Chan field and type the number “2” (See Fig. 280)



FIG. 280: PROCESS DATA/SELECTING GROSS WEIGHT/CHANNEL 2

Step 28. Click on the Select button. Gross Weight/Channel 2 (HF15) appears in the Current Mappings field to the right of the Hardy Control-Link Float Out selection (EFO4).

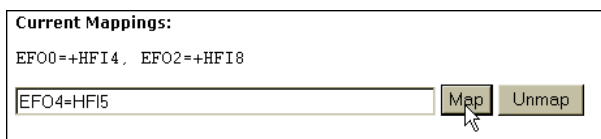

FIG. 281: CURRENT MAPPINGS/GROSS WEIGHT/CHANNEL 2 (HF18) ASSIGNED TO HARDY CONTROL-LINK FLOAT OUT/WORD 4 (EFO4)

Step 29. Click on the Map button to map the assignment statement. (See Fig. 281)

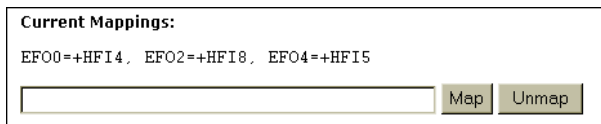

FIG. 282: GROSS WEIGHT ASSIGNED TO HARDY CONTROL-LINK FLOAT OUT

Step 30. Click on the left arrow to return to Page 1.
 Step 31. Click on the Network pull down list and select Hardy Control-Link Float Out again.

Step 32. This time type the number “6” in the Word field. (See Fig. 283)

NOTE: Remember the Items in the Host Message on the OPC Server consist of two words.



FIG. 283: HARDY CONTROL-LINK FLOAT OUT/WORD 6

Step 33. Click on the Select button. Hardy Control-Link Float Out Word 2 (EFO6) appears in the Current Mappings field.



FIG. 284: HARDY CONTROL-LINK FLOAT OUT/WORD 4 SELECTED AS DESTINATION

Step 34. Click on the “Jump to Sources Page” button. Mapping Setup 2 appears.

Step 35. Click on the Process Data pull down list. (See Fig. 285)

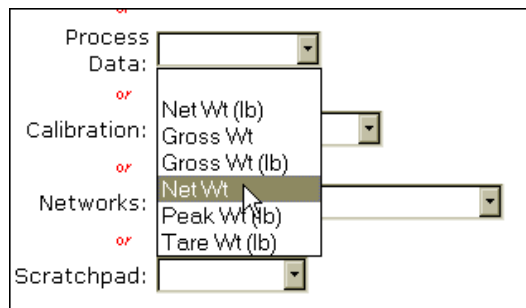

FIG. 285: MAPPING PAGE 2 SELECTING NET WEIGHT

Step 36. Click on Net Wt. Net Wt appears in the Process Data field with Chan 1 to the right. Click in the Chan field and type the number “2” (See Fig. 286)



FIG. 286: PROCESS DATA/SELECTING NET WEIGHT/CHANNEL 2

Step 37. Click on the Select button. Net Weight/Channel 2 (HFI9) appears in the Current Mappings field to the right of the Hardy Control-Link Float Out selection (EFO6) (See Fig. 287).

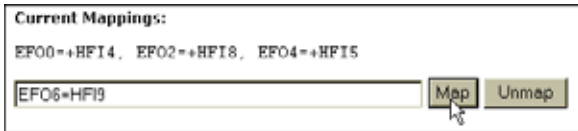

FIG. 287: CURRENT MAPPINGS/GROSS WEIGHT/CHANNEL 2 (HFI9) ASSIGNED TO HARDY CONTROL-LINK FLOAT OUT/WORD 4 (EFO4)

Step 38. Click on the Map button to map the assignment statement. (See Fig. 288)

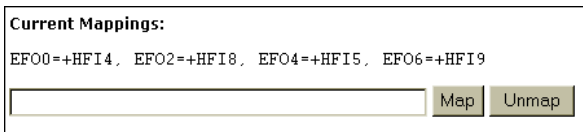

FIG. 288: GROSS WEIGHT ASSIGNED TO HARDY CONTROL-LINK FLOAT OUT

Step 39. You can continue this process up to Item FO62.
Step 40. To see what has been mapped click on the word [here](#) in the statement “Click [here](#) for an expanded map”. (See Fig. 289) The Expanded Map dialog box appears. (See Fig. 290)

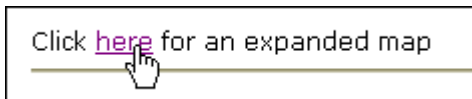

FIG. 289: SELECTING AN EXPANDED MAP

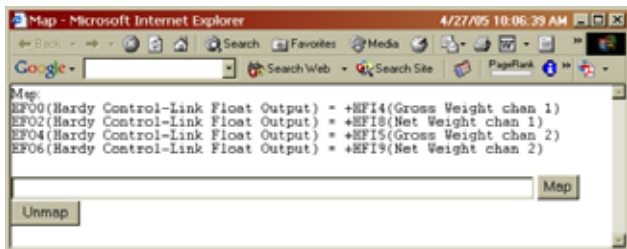

FIG. 290: EXPANDED MAP DIALOG BOX

- Here is a table to show the mapping for the OPC Server.

Item #	Destination	Source
FO00	Hardy Control-Link Float Output - Word 0 (EFO0)	Gross Weight Channel 1 (HFI4)
FO02	Hardy Control-Link Float Output - Word 2 (EFO2)	Net Weight Channel 1 (HFI8)
FO04	Hardy Control-Link Float Output - Word 4 (EFO4)	Gross Weight Channel 2 (HFI5)
FO06	Hardy Control-Link Float Output - Word 6 (EFO6)	Net Weight Channel 2 (HFI9)

Configuring EtherNet/IP Using RSLogix5000®

These configurations procedures assume that RSLogix5000® and ControlLogix5000® with an EtherNet/IP™ module/bridge are set up and working correctly.

NOTE: RSLogix5000® and ControlLogix5000® are registered trademarks of Rockwell Automation Inc.

NOTE: The dip switches do not function. It is a good idea to leave all of them in the OFF position.

- Step 1. Create a new project or use an existing project and set the program in “Offline” mode.
- Step 2. Right click the EtherNet/IP module/bridge in the I/O configuration. (See Fig. 291)

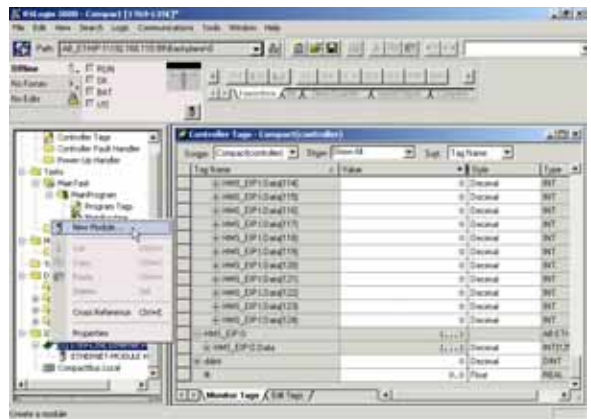

FIG. 291: I/O CONFIGURATION/ADDING A NEW MODULE

Step 3. Click on New Module. The Select Module type dialog box appears. (See Fig. 342)

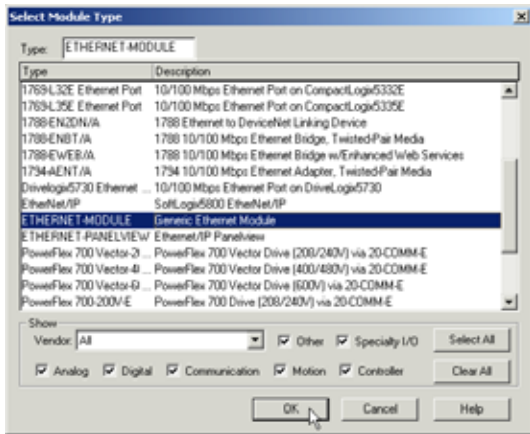

FIG. 292: SELECT MODULE TYPE

- Step 4. Scroll down until you find “ETHERNET-MODULE Generic Ethernet Module”
- Step 5. Click on the Generic Ethernet Module.
- Step 6. Click on the OK button to select the module type. The Module Properties - EtherNet_Bridge (ETHERNET-MODULE 1.1) dialog box appears. (See Fig. 293)

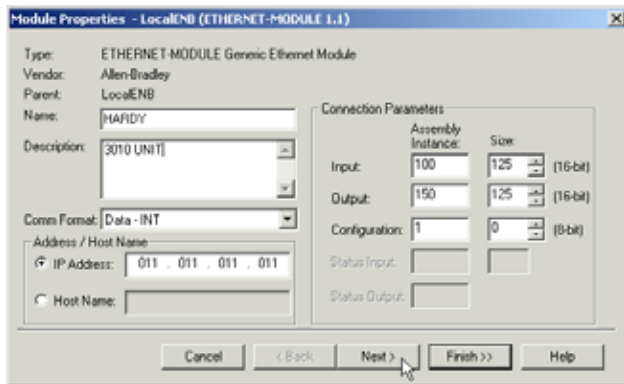

FIG. 293: MODULE PROPERTIES DIALOG BOX

- Step 7. In the text field next to Name type in the name you want to use for the module. In our example we used Hardy.
- Step 8. In the Description text field type in a description of the module. In our example we entered 3010 Unit.
- Step 9. Click on the Comm Format pull down menu.
- Step 10. Click on “Data-INT”.
- Step 11. Click in the IP address field.
- Step 12. Enter the IP address of the module you are configuring.
- Step 13. Under “Connection Parameters” enter the following:

Assembly Instance	Size
100	125
150	125
1	0

- Step 14. Click on the Next button.
- Step 15. In the Requested Packet Interval (RPI) field use the up or down arrows to select 50 milliseconds, or double click in the field and type 50.0. (See Fig. 294)
- Step 16. Make sure that the Inhibit Module is not checked.

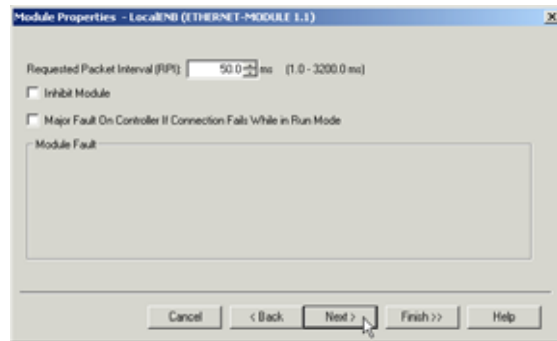

FIG. 294: REQUESTED PACKED INTERVAL/ SELECTING 50.0 MILLISECONDS

Step 17. Click on the Next button or the Finish button. The original dialog appears with the newly added “ETHERNET-MODULEHARDY” added to the I/O configuration list and the Controller Tags list. (See Fig. 295)



FIG. 295: ETHERNET-MODULE HARDY ADDED TO I/O CONFIGURATION LIST

Step 18. This completes the EtherNet/IP configuration for the Hardy HI 3000 Modules.

Mapping

Mapping is used to:

1. Configure local inputs and outputs of the 3000 Controller using Boolean or non-Boolean statements.
2. Map parameters between Controllers using an Ethernet Network. (Hardy Control-Link)
3. Map parameters, setpoints, or commands between the local controller and any of the supported communication networks, including ControlNet, Allen-Bradley Remote I/O, Profibus and DeviceNet.

Note: The 3000 Controllers are Masters on DeviceNet, meaning any parameter can be assigned (mapped) to 3rd party I/O on the DeviceNet Network. The Rockwell Automation software package "RSNetwork" is used to assign the I/O on the plant network.

Any number of Sources can be mapped to one Destination using the Boolean Statements in the Advanced Mapping Screen.

- Step 1. Select One Destination from the pull down lists in the Local, Network, or Control fields. Once selected, the Destination will automatically fill in on the left-hand side of the equation in the mapping field.
- Step 2. Select one Source in the same manner as in step a. The source can reside in the local controller as a parameter, as a point on one of the network tables, or as a parameter on another 3000 Controller on the network. Once selected, the source will automatically fill in on the right-side of the equation in the mapping field.
- Step 3. If more than one source is desired, select one of the Boolean Operators (And, Or, Not), and then repeat step 2 to select the next source.
- Step 4. To initiate the displayed mapping equation, select the 'Map' key.
- Step 5. To Unmap - Highlight the Mapping you want to unmap. Copy and paste the map into the Map text field. Press the Unmap button. The Mapping disappears from the list.
- Step 6. For more information about Mapping go to the Mapping Chapter for each individual HI 3000 Series product.

E-MAIL: CONFIGURATION AND OPERATION

Overview

The HI 3000 Series instruments are configured with E-mail capability (SMTP Sender) that enables the user to send either Basic Alarm E-mails or Custom Event E-mails to remote locations on a local network, wide area network or the Internet. The E-mail capability allows the user to maintain a system update automatically listing any alarm conditions or events that occur in the weigh process or condition monitoring system. It provides an alternative to networked audio or video alarms which cannot be detected when personnel are away from the process or control room itself or outside of the plant. In addition you can configure the filters in your browser to collect certain E-mails for a certain category.

NOTE: The HI 3000 Series Instruments cannot receive E-mail messages.

The Standard Format E-mail allows the user to specify up to 3 groups of E-mail addresses where alarms can be sent. The 3 groups of E-mail addresses can list as many as can fit in a 240 character address field per group. For example:

- jasonoverby@newhallinstruments.com, robertsmith@whachamcallitsystems.com, sallycincinatti@panhellenicstridentinstruments.com - will yield fewer group addresses.
- jdoe@ace.com, pallison@ltv.com, csnow@acme.com - will yield far more group addresses.

In addition to each E-mail address, the user can select which events/alarms are forwarded by selecting the setpoints (1-12) from a list which sends a predefined formatted E-mail to the list of E-mail addresses in the group. There is no limit as to how many events/alarms can be forwarded to an E-mail address.

The Custom Format E-mail is configured using the Custom Event E-mail Setup web page and the Mapping Web Page. The Custom Event E-mail allows the user to define the Destination, Subject and Body of the E-mail. In addition to the three main parts of an E-mail the user can define which events trigger the E-mail. This is accomplished by defining the events through the use of tokens (< >) in the body of the E-mail. To illustrate:

Body = <2C0><50><HO0.0>

<2C0> is the parameter for Gross Weight on Channel 1 and is replaced by the words - "Gross Weight"

<50> is replaced by the current date and time.

<HO0.0> is replaced by a floating point integer reflecting the actual Gross Weight - 100.000

All configuration procedures must be performed from the web-browser. The DNS server address can be entered from the front panel of any HI 3000 Series Instrument.

Understanding IP Addresses

An IP address consists of four octets (1 octet = 8 bits), or 32 bits. The value in each octet ranges from 0 to 255 decimal, or 00000000 - 11111111 binary.

These octets are broken down to provide an addressing scheme that can accommodate large and small networks. There are five different classes of networks, A to E. Here, we'll only be addressing classes A to C, since classes D and E are reserved. To determine the class of an address, look at the first octet of the dotted-decimal address.

Class A: 1 - 126 (e.g. **10**.1.23.19)

Class B: 128-191 (e.g. **172.16**.19.48)

Class C: 192-223 (e.g. **193.18.9**.10)

In a class A address, the first octet is the network portion, so the class A example above has a major network address of **10**. Octets 2, 3, and 4 (the next 24 bits) are for the network manager to divide into subnets and hosts as she/he sees fit. Class A addresses are used for networks that have more than 65,536 hosts (actually, up to 16,581,375 hosts!).

In a class B address, the first two octets are the network portion, so the class B example above has a major network address of **172.16**. Octets 3 and 4 (16 bits) are for local subnets and hosts. Class B addresses are used for networks that have between 256 and 65,536 hosts.

In a class C address, the first three octets are the network portion. The class C example above has a major network address of **193.18.9**. Octet 4 (8 bits) is for local subnets and hosts - perfect for networks with less than 256 hosts.

Glossary of E-Mail Terms

Gateway

A node on a network that serves as an entrance to another network. In enterprises, the gateway is the computer that routes the traffic from a workstation to the outside network that is serving the Web pages. In homes, the gateway is the ISP that connects the user to the internet.

SMTP

Short for **Simple Mail Transfer Protocol**, a protocol for sending e-mail messages between servers. Most e-mail systems that send mail over the Internet use SMTP to send messages from one server to another; the messages can then be retrieved with an e-mail client using either POP or IMAP. In addition, SMTP is generally used to send messages from a mail client to a mail server. This is why you need to specify both the POP or IMAP server and the SMTP server when you configure your e-mail application.

DNS

Short for **Domain Name System (or Service)**, an Internet service that translates domain names into IP addresses. Because domain names are alphabetic, they're easier to remember. The Internet however, is really based on IP addresses. Every time you use a domain name, therefore, a DNS service must translate the name into the corresponding IP address. For example, the domain name www.example.com might translate to 198.105.232.4.

The DNS system is, in fact, its own network. If one DNS server doesn't know how to translate a particular domain name, it asks another one, and so on, until the correct IP address is returned.

POP

Short for **Post Office Protocol**, a protocol used to retrieve e-mail from a mail server. Most e-mail applications (sometimes called an e-mail client) use the POP protocol. There are two versions of POP. The first, called POP2, became a standard in the mid-80's and requires SMTP to send messages. The newer version, POP3, can be used with or without SMTP.

Configuring the E-Mail Server

Step 1. Contact your Network Administrator for the correct settings. You will need the following:

- Name or IP Address of the Mail Server
- Mail User ID
- Return Mail Address
- E-Mail Password (if required)

Step 2. From the Instrument Home Web Page click on Configuration. (See Fig. 296) The Configuration web page appears. (See Fig. 297)



FIG. 296: INSTRUMENT HOME PAGE/SELECTING CONFIGURATION

Configuration

[Adjust Setpoint](#)

[Instrument Setup](#)

[Calibration](#)

[Basic Mapping](#)

[Advanced Mapping](#)

[Security](#)

[Email](#)

[Options](#)

FIG. 297: CONFIGURATION WEB PAGE/SELECTING E-MAIL

Step 3. Click on Email. The E-Mail Configuration Web Page appears. (See Fig. 298)

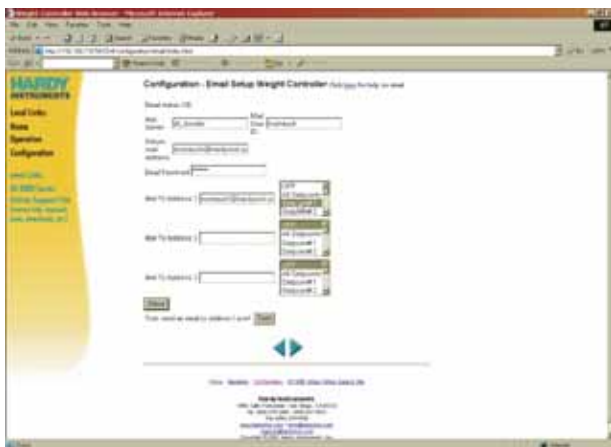

FIG. 298: E-MAIL CONFIGURATION WEB PAGE

- Step 4. Click in the text field next to “Mail Server” and enter either the Mail Server name or the Mail Server IP Address.

Entering the Mail Server Name from the Front Panel

- Step 1. If you enter a name for the Mail Server you need to first enter the DNS Server Address from the front panel of the HI 3000 Series Instrument as follows:

- From the Front panel of the HI 3000 Series Instrument press the Setup/3 button. The Configuration Menu appears. (See Fig. 299)

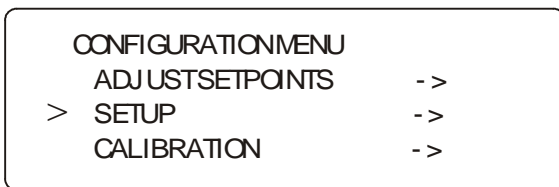

FIG. 299: CONFIGURATION MENU/SELECTING SETUP

- Press the down arrow button until the cursor is in front of SETUP.
- Press the Enter button. The Setup Menu appears. Press the up arrow button until the cursor is in front of Ethernet. (See Fig. 300)

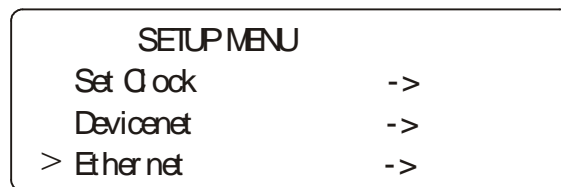

FIG. 300: SETUP MENU/SELECTING ETHERNET

- Press the Enter button. The Ethernet sub-menu appears. (See Fig. 301)

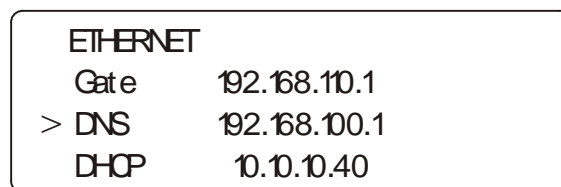

FIG. 301: ETHERNET SUB-MENU

- Press the Down Arrow button until the cursor is in front of DNS. (See Fig. 301)
- Press the Clr button to clear the entry. Use the alphanumeric keypad to enter the DNS Server IP Address. If you do not know the IP Address, contact your Network Administrator for the IP Address.

NOTE: The IP Address consists of 4 octets with a period between each octet. Make sure you enter the periods between each octet (set of numbers).

- Press the Enter Button to set the entry.
- Press the Exit button until you return to the Main Menu.
- The DNS Address is set.

Step 2. Enter the Mail Server IP Address.

Step 3. If you are sending E-mail outside your local area network (segment) you need to get the following three IP addresses from the Network Administrator and do the following:

- Instrument IP Address
- DNS IP Address
- Gateway IP Address

NOTE: You must enter these IP Addresses whether you are using a Mail Server name or IP Address.

- To enter the IP Addresses, press the up or down arrow buttons until the cursor is in front of Add. (See Fig. 302)

ETHERNET	
> Addr	192.168.10.55
Mask	255.255.0.0
Gate	192.168.10.1

FIG. 302: ETHERNET MENU/ENTERING INSTRUMENT IP ADDRESS

- Press the Clr button to clear the entry.
- Use the alphanumeric key pad to enter the Instrument Address.
- Press the Enter button. This sets the Instrument IP Address.
- Press the down arrow button until the cursor is in front of Gate (Gateway). (See Fig. 303)
- Press the Clr button to clear the entry.
- Use the alphanumeric key pad to enter the Gateway Address.
- Press the Enter button. This sets the Gateway IP Address.
- Press the down arrow button until the cursor is in front of DNS. (See Fig. 303)

ETHERNET	
Gate	192.168.10.1
> DNS	192.168.10.1
DHCP	10.10.10.40

FIG. 303: ETHERNET MENU/ENTERING DNS IP ADDRESS

- Press the Clr button to clear the entry.
- Use the alphanumeric key pad to enter the Gateway Address.
- Press the Enter button. This sets the DNS IP Address.
- Press the Exit button until you return to the main menu.

Step 4. Now that you have entered the Mail Server Name go back to the Web Page.

Continuing E-Mail Configuration from the Web Page

Step 5. Click in the text field next to Mail User ID. Enter your Mail User ID (Account) name or number.

- If you do not know what your account number is, contact your Network Administrator for this information.
- If you do not have an account number have your Network Administrator set one up.

Step 6. Click in the text field next to Return Mail Address. This is the address that appears in the “From” field of the E-mails that are sent from the HI 3000 Series Instrument. (See Fig. 304)

FIG. 304: SETTING THE STANDARD 3-MAIL/MAIL SERVER, USER ID, RETURN MAIL ADDRESS

- Step 7. Click in the text field next to Password.
- If a password is required type it in.
 - If a Password is not required leave the text field blank.

Configuring Standard E-Mail

- Step 1. Click in the text field next to “Mail to Address 1”. If there is already an address in this text field doubleclick to highlight the entire entry.
- Step 2. Type in the E-Mail Address you want the event or alarm e-mail(s) sent to. (See Fig. 305)

FIG. 305: SETTING THE STANDARD E-MAIL “MAIL TO” ADDRESSES AND SELECTING SETPOINTS

- Step 3. In the List of Setpoints click on the setpoints you want included in the E-Mails. (See Fig. 305) You can Select All Setpoints by clicking on All Setpoints. If you want to select less than 12 setpoints, click and hold down the Ctrl (Control) button. Place the cursor over the Setpoints you want to include and left click.
- Step 4. Repeat this process for every Setpoint you want to include.
- Step 5. Repeat steps 1-4 for “Mail to Address or Group 2” and “Mail to Address or Group 3”.
- Step 6. Click on the Save Button.
- Step 7. If you need assistance click on [help](#) at the top of the page.
- Step 8. This completes the Standard E-Mail Configuration.

Configuring Custom E-Mail

About Custom E-Mail

The Custom E-Mail has 10 user defined templates which you can select from the E-Mail # pull down menu. Each template has a to address, subject and body. You can modify the templates to fit your requirements by double clicking in each field you want to change. When you save a modified template, that will now become the template for that E-mail number. Now when you click on the E-mail #, the modified template appears in the text field in place of the original template's information. The “To Address” is the E-mail address you wish to receive the E-Mail. The “Subject” appears in the Subject field. The E-Mail message text is located in the Body text field.

- Step 1. Click on the right arrow in the Standard E-Mail Web page, the Custom E-Mail page appears. (See Fig. 306)



FIG. 306: CUSTOM E-MAIL WEB PAGE

- Step 2. Click on the E-mail # pull down menu and select the E-mail template you want. The preselected tem-

plate information appears in the To Address, Subject and Body.

- Step 3. If you are satisfied with the configuration in the original template click on the Save button.
- Step 4. To change the text fields, double click in the fields to highlight the text and type in the new information. (See Fig. 307)



FIG. 307: E-MAIL TEMPLATE FOR E-MAIL #0

- Step 5. Click in the “To address text field”. Type in the address you want the E-mail sent to. Make sure to use the “at symbol (@)” between the User Name and the Domain Name, otherwise the server will not know that it is an E-Mail. Also make sure you put the correct extension to determine the type of organization the E-mail is being sent to (e.g. .com, .org, .edu, .net etc.). (See Fig. 308)

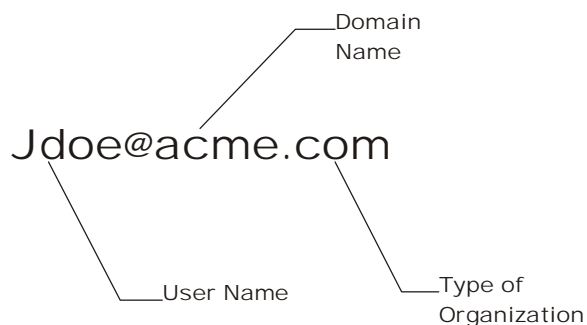

FIG. 308: PARTS OF AN E-MAIL ADDRESS

About Tokens

Tokens are symbols that you enter in the subject or the body of the Custom E-mail to format the E-mail or to insert a parameter value. Tokens begin with the “less than” symbol (<) and end with the “greater than” symbol (>). You can enter any of the instrument's parameter values by using the tokens with the form <PARAMETERNUMBER>, where

PARAMETERNUMBER is the parameter number in hexadecimal format, for example Gross Weight = <2C0>. To get a list of the Parameter Numbers click on [parameters](#). The Parameter Dump page appears listing the Parameters for the HI 3000 Series instrument you are connected to. (See Fig. 309)

**Operation - Diagnostics
 Parameter Dump**

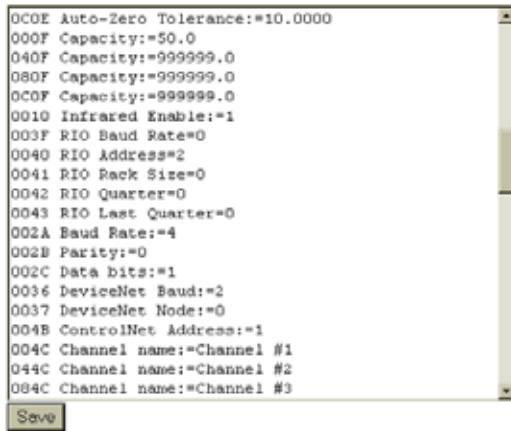

FIG. 309: LIST OF PARAMETER DESCRIPTIONS AND HEXADECIMAL NUMBERS

You can also place the value of any MAP term into the E-mail by using tokens with the form <MAPTERM>. To get a list of the MAP terms, click on [map](#). The MAP Dictionary appears. (See Fig. 310)



FIG. 310: MAP DICTIONARY

Step 6. Double click in the “Subject Text Field”. Enter a description of the type of E-mail you are sending. In our example we used “A custom E-mail from <1>”. You can type in any description you want but you must put in the Parameter number or MAP

Value between the tokens. In our example <1> refers to the Hexadecimal number for Operator ID which is 0001. Note that the Operator ID parameter number is 0001. You can enter the leading zeroes or leave them out whichever you prefer.

Step 7. Click in the Body Text Field. Enter the Parameter number in hexadecimal notation. In our example we entered the Gross Weight Parameter <2C0>.

NOTE: Gross Weight is a read only parameter.

Step 8. Enter the Time and Date Parameter #50. <50> This is replaced with the current date and time.

Step 9. Enter the Digital Output “<HO0.0>”. This is replaced by a floating point number, either 0 or 1 depending on the state of HO0.0 (Relay 1)

Step 10. To see an expanded version of the tokens click on [expand](#). The Expanded Report appears with the tokens replaced by the Parameter, Date and Time. Expanding the tokens is a good idea to make sure the parameter numbers entered are what you are looking for in an E-mail report. (See Fig. 311)

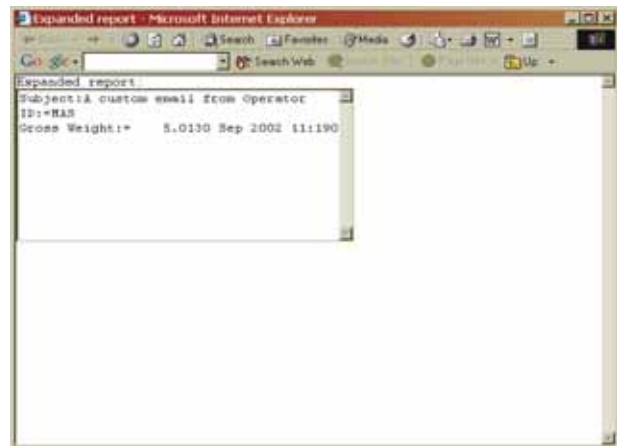

FIG. 311: EXPANDED VIEW OF ENTERED TOKENS

Step 11. Click on the Save button to save the E-mail configuration.

Step 12. Custom E-mails are sent when the “E-mail trigger bit” associated with it changes from a 0 to a 1. The 10 trigger bits are located in Word 3 of the Hardy Output Table (HO3.0, HO3.1, and so on)

HO - Hardy Output Table

HO3.0 - HO3.9 = E-mail Trigger Bits

You need to define an equation that establishes when the bits are set. To define an equation that determines when these bits are set, go to the Mapping Setup Page.

Step 13. Click on Configuration. The Configuration Web page appears. (See Fig. 312)

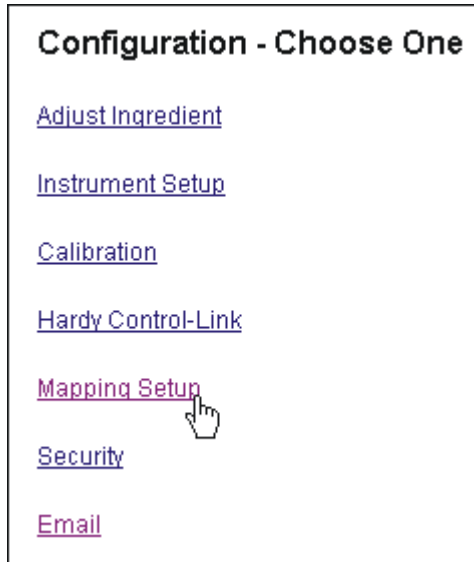

FIG. 312: CONFIGURATION WEB PAGE/ SELECTING MAPPING SETUP

Step 14. Click on Mapping Setup. The Mapping 1 Web Page appears. (See Fig. 313)

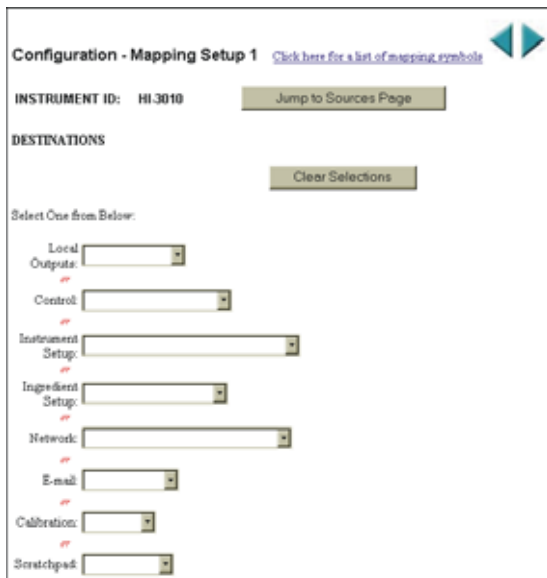

FIG. 313: MAPPING SETUP1/SENDING CUSTOM E-MAIL

Step 15. For our example we used the following equation: $HO3.0 = HI0.0$ which says in effect “send Custom E-mail #0 when Local Input 1 (HI0.0) goes to 1. Click on the E-mail pull down menu. (See Fig. 314)

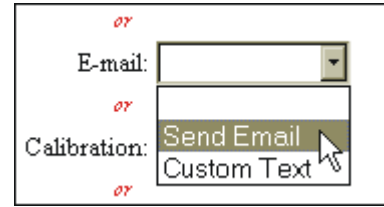

FIG. 314: MAPPING SETUP 1/SELECTING SEND EMAIL

Step 16. Click on Send Email. Send Email appears in the menu and Email # appears to the right with a Select button. You can create up to 10 custom e-mails. Simply type in the e-mail number you want to go with Local Input #1. In our example we selected Email #0. (See Fig. 315)

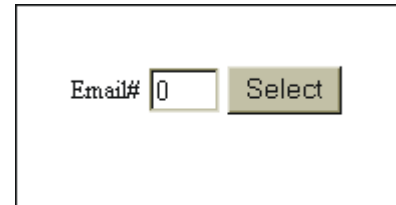

FIG. 315: ENTERING EMAIL NUMBER

Step 17. Click on the Select button. The Destination HO3.0 appears on the left hand side of the equation. (See Fig. 316)



FIG. 316: SEND EMAIL #0 ENTERED IN THE EQUATION

Step 18. Click on the Jump to Sources Page. The Mapping Setup Page 2 appears. (See Fig. 317)

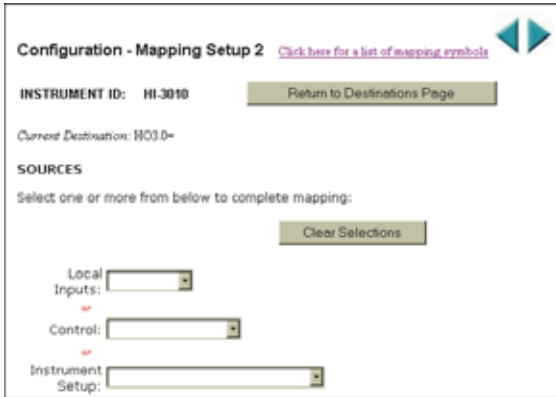

FIG. 317: MAPPING SETUP 2 PAGE

Step 19. Click on any of the pull down menu you want to assign to the e-mail. In our example we selected Local Input. (See Fig. 318)

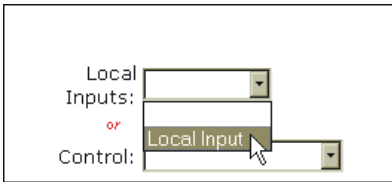

FIG. 318: SELECTING LOCAL INPUTS

Step 20. When you select Local Input, to the right of the Input# a select button appears. (See Fig. 319)

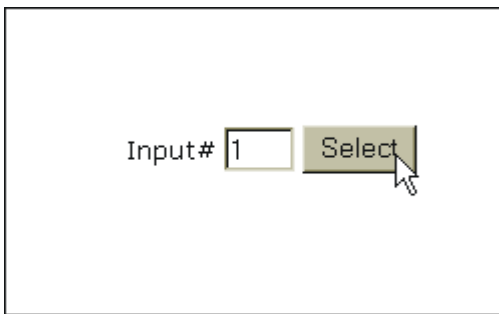

FIG. 319: SELECTING LOCAL INPUT #1

Step 21. Click on the Input# text field and type in the Local number you want (1 - 5). Click on the Select button. The Source appears on the right side of the equation. (See Fig. 320)

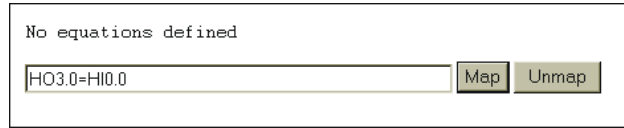

FIG. 320: EQUATION ENTERED (HO3.0=HI0.0)

Step 22. Click on the Map button. The equation appears above the Map and Unmap text field. (See Fig. 321) This means that the mapping process is complete.

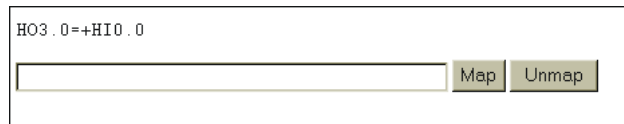

FIG. 321: E-MAIL MAPPING COMPLETE

Step 23. Another mapping method, if you know the Destination and Source addresses, is to type them into the Map text field. In our example simply type: HO3.0=+HI0.0. Click on Map and your are done.

Testing E-Mail

To test the Standard or the Custom E-mail do the following:

- Step 1. Click in the Test Address text field.
- Step 2. Type in the e-mail address you want the test message to go to. (See Fig. 322)

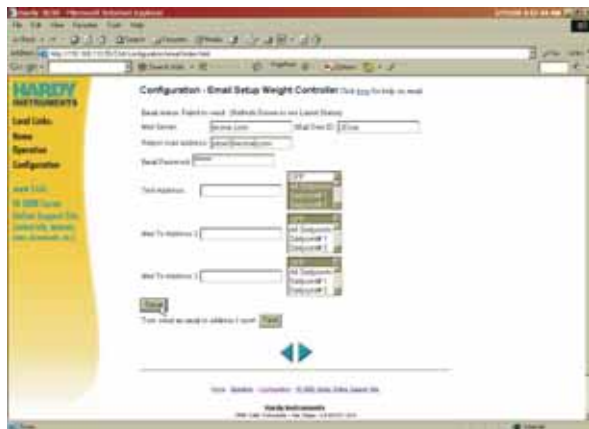

FIG. 322: TESTING E-MAIL

- Step 3. Click on the Save Button to save the e-mail and settings.
- Step 4. Click on the Test button. The e-mail is sent to the Test Address.

- Step 5. If the e-mail does not arrive at the test destination, check your configuration again and reconfigure your e-mail.
- Step 6. Test the e-mail again until the mail is successfully delivered to the test address.

Setting up Filters in E-mail Applications

You can set up filters in Microsoft® Outlook® which sort the E-mails into preselected categories. Check their User Guide or Help sections to find out how to create Filters.

NOTE: Outlook® is a registered trademark of the Microsoft Corporation.

SECURITY: SETUP

Overview

The HI 3000 Series products all have security capability where the manager can set Medium and High security levels for each high level menu. All the HI 3000 instruments have a built in Low Security Level which is the default setting. There are some Menus that you cannot enter, such as the Security Menu, Factory Default Menu or Self Test Modify Menu. These Menus are reserved for supervisors, engineers or service personnel. Once an Ingredient or instrument is configured or calibrated you may want to secure these menus from being changed by operators or other personnel who are not directly involved in the HI 3000 Series Controlled process. Setting a Medium or High security level for an instrument considerably reduces the possibility of problems that might arise from unauthorized personnel changing critical control parameters which may result in misprocess or catastrophic system failure.

Security Levels

- Low - Requires no password
- Medium - Requires password to access some but not all top level menus.
- High - Requires password to access all top level menus.

All Top level menus (except security) can be assigned their own security level. These include:

- Adjust Ingredient
- Setup
- Calibration
- Options
- I/O Mapping

If a menu has a Non-Low Security Level, when a user enters the menu a password is requested. If the user enters a bad password or no password the user is given read access only to all sub-menus.

Setting up Passwords from the Front Panel

Step 1. From the Standby Display press the Setup button. The Configuration Menu appears. (See Fig. 323)

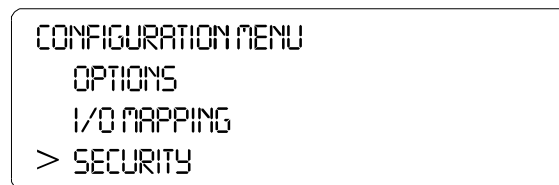

FIG. 323: CONFIGURATION MENU/SELECTING SECURITY

- Step 2. Press the up or down arrow buttons until the cursor is in front of “SECURITY”. (See Fig. 323)
- Step 3. Press the Enter button. The Security Menu appears with the cursor in front of “Set Security Menu”. (See Fig. 324)

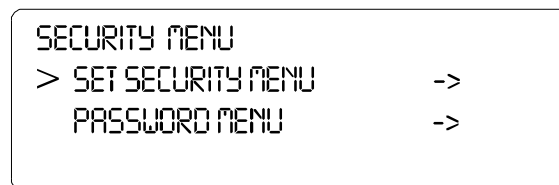

FIG. 324: SECURITY MENU/SETTING SECURITY MENU

- Step 4. Press the Enter button. The Set Security Menu appears with the High Level Menus listed with default LOW security levels. (See Fig. 325)
- Step 5. Press the up or down arrow buttons until the cursor is in front of the selected menu.

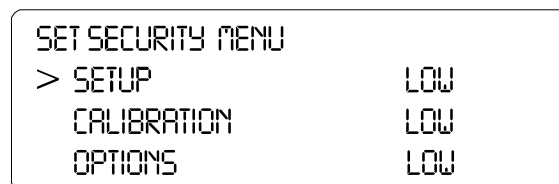

FIG. 325: SET SECURITY MENU

NOTE: The menus in Figure 325 are for illustration purposes only. Each instrument will have different menus. There are more menus than the three that are shown. You will have to scroll down through the menu to see all of them.

Step 6. Press the left or right arrow buttons until the security level you want to set for the selected menu appears.

- Step 7. Press the Enter button to set the entry.
- Step 8. Continue Steps 5 -7 until you have set the security levels for the selected menus. (See Fig. 326)

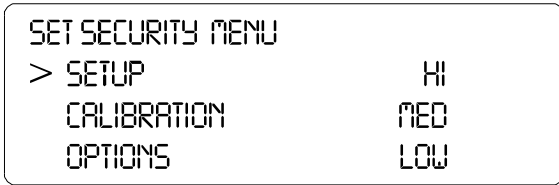

FIG. 326: SECURITY LEVELS ASSIGNED FOR EACH MENU

- Step 9. Press the Exit button until you return to the Standby Display.

Setting up Passwords from the Browser

- Step 1. From the HI Series 3000 Home Page, click on Configuration. (See Fig. 327) The Configuration Page appears. (See Fig. 328)



FIG. 327: HOME PAGE/SELECTING CONFIGURATION

NOTE: For illustration purposes we selected the Filler/Dispenser/IBC Home page. It could be any Home page for any of the HI 3000 Series controllers.

Configuration

[Adjust Ingredient](#)

[Instrument Setup](#)

[Calibration](#)

[Basic Mapping](#)

[Advanced Mapping](#)

[Security](#)

FIG. 328: CONFIGURATION PAGE/SELECTING SECURITY

- Step 2. Click on Security. An Enter Password Dialog box appears. If you are setting up the security for the first time, just type "0" without the quotation marks in the Password field. If this is a change in the settings you will have to enter the password that allows you to enter the security page. (See Fig. 329)



FIG. 329: ENTER NETWORK PASSWORD DIALOG BOX

- Step 3. If you want to save the password in the password list click on the check box to next to "Save the password in your password list."
- Step 4. Click on OK.
- Step 5. If you entered an incorrect number or no number nothing happens. If you try three times and the password is still not correct an Error page appears. (See Fig. 330) Contact you Network Administrator for the correct password.

Your Authentication failed

Your Request was denied
You do not have permission to view this page

FIG. 330: PASSWORD AUTHENTICATION FAILED

- Step 6. To return to the Dialog Box, click on the browser back arrow.
- Step 7. If you are setting up the security page for the first time, (i.e. no passwords or security levels have been setup) the Security Page appears with default settings. (See Fig. 331)
- Step 8. The Security Page appears with the previous settings.

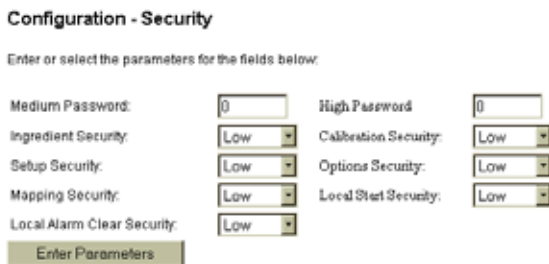

FIG. 331: CONFIGURATION/SECURITY PAGE

- Step 9. Click in the Medium Password field and type in a 1-4 digit password. (See Fig. 331) For example 1234.
- Step 10. Click in the High Password field and type in a 1-4 digit password. (See Fig. 332) For example 5678.

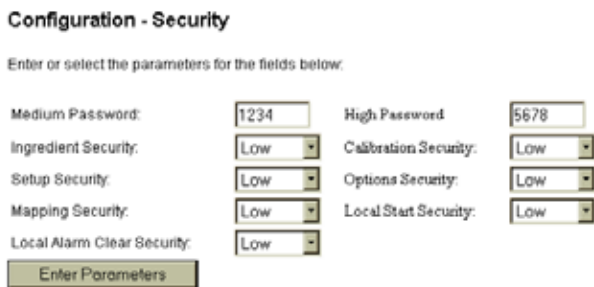

FIG. 332: CONFIGURATION - SECURITY PAGE TYPING PASSWORDS

- Step 11. Click on a pull down menu next to the Menu you want to enter a security level. (See Fig. 333)
- Step 12. Click on the level you want to set. Low, Medium, or High.

Configuration - Security

Enter or select the parameters for the fields below:

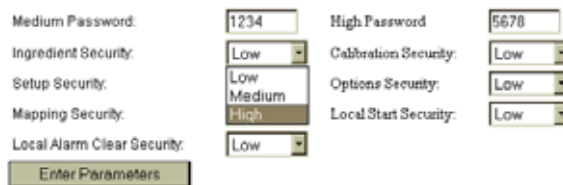

FIG. 333: CONFIGURATION - SECURITY/ SELECTING SECURITY LEVEL FOR A MENU

- Step 13. Continue to set the security levels for the High Level Menus you select. (See Fig. 334)

Configuration - Security

Enter or select the parameters for the fields below:



FIG. 334: CONFIGURATION - SECURITY/ PARAMETERS SET FOR SECURITY LEVELS

- Step 14. Click on the Enter Parameters button.
- Step 15. Security Levels Setup Complete.
- Step 16. If you forget your security level just log on to the instrument.

Log On Procedures

When operating an HI Series 3000 instrument it is a good idea to log onto the instrument. Log On means that you enter your User ID along with the password. This establishes your security level allowing you to use the menus for your level of security.

Logging on from the Front Panel

- Step 1. From the Standby display press on the User/. button. The Enter User Name Display appears. (See Fig. 335)
- Step 2. Press the Clr. (Clear) button to clear the entry.
- Step 3. Use the alphanumeric keypad to enter your user name.

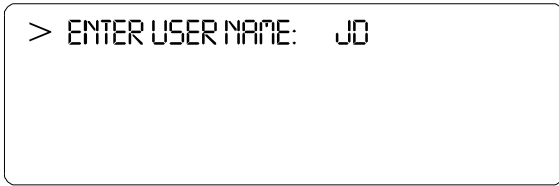

FIG. 335: LOGGING ON/ENTERING USER NAME

Step 4. Press the Enter button to set the entry. The Enter Password Display appears. (See Fig. 336)



FIG. 336: LOGGING ON/ENTERING PASSWORD

Step 5. Press the Clr. (Clear) button to remove the previous entry.
 Step 6. Type in your password.
 Step 7. Press the Enter button to set the entry. The Security Level Status display appears. This is a read only display listing your security level status. (See Fig. 337)

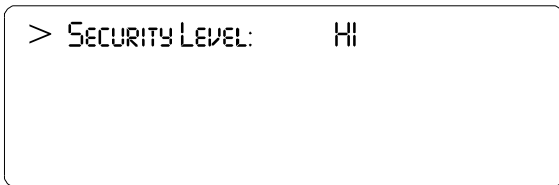

FIG. 337: LOGGING ON/STATUS DISPLAY - SECURITY LEVEL HI

Step 8. Press the Exit button until you return to the Standby Display.
 Step 9. Log On Complete.

Log On from the Browser

Unlike the Front Panel you cannot Log On or Log off the instrument from the browser. However if security levels have been set, you can be required to log into a Menu. If you try to enter a menu with a security level, a Log On dialog box appears which asks you to enter your User ID and Password. (See Fig. 338)



FIG. 338: LOG ON/ENTER NETWORK USER ID AND PASSWORD

Step 1. Enter you user ID.
 Step 2. Enter your Password
 Step 3. Click on OK to gain access to the Menu.

Log Off Procedures from the Front Panel

Quite often a user may want to log on to the instrument to do some configuration or a calibration. It is a good idea to log off the instrument after you complete the tasks to avoid another user, who may not have as high a security level as you, from accessing secure menus.

Step 1. From the Standby display press on the User/. button. The Enter User Name Display appears. (See Fig. 339)

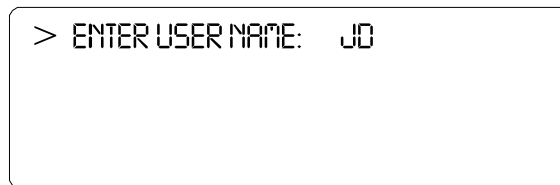

FIG. 339: REMOVING USER NAME

Step 2. Press the Clr button to clear your user name.
 Step 3. Press the Enter button to set the entry.
 Step 4. Press on the Enter Button. The Enter Password Display appears. (See Fig. 340)

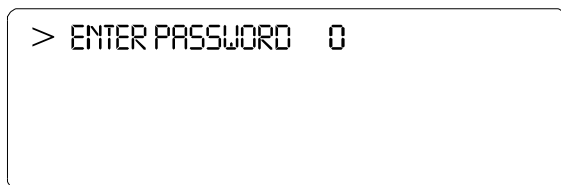

FIG. 340: ENTER A “0”

- Step 5. Press the Clr. (Clear) button to clear your password.
- Step 6. You can press the Enter button to set the security level to default LOW or you can enter a “0” to reset the security level of the instrument to a default LOW level.
- Step 7. Press the Exit button until the Standby Display appears.
- Step 8. You have now logged off the instrument.

HI 3001: MASTER DISPLAY

Overview

The HI 3000 Series Master Display (HI 3001) allows the user to configure, operate and calibrate up to sixteen (16) HI 3000 Series Instruments from the Master Display Front panel. The unique interface allows the user to select the instrument and operate the instrument from the Master display as if the user was operating the selected instrument itself. When you select the instrument you want, the HI 3001 Master Display virtually becomes that instrument, making all the instrument's functionality available to the user. The Master Display automatically senses and lists all the HI 3000 Instruments connected to the Hardy Control-Link Network. By pushing the Station button you can move through the list until the instrument you want to operate is displayed. Simply push the Enter button and the HI 3000 Station can be operated from the front panel of the Master Display. By mounting the Master Display in the Control Room or in any convenient location, you can operate, configure and calibrate an instrument without having to go to the instrument itself. Excellent for operating HI 3000 blind remote stations.

Getting Started

Before operating the Hardy HI 3001 Master Display, check to make sure the following procedures have been performed:

- Power and Load Point cables properly installed.
- Communication cables properly installed.
- Calibration Performed.

All the features of the Master Display operate the same no matter what the interface. First let's get familiar with operating the Master Display from the front panel of the instrument. (See Fig. 341)

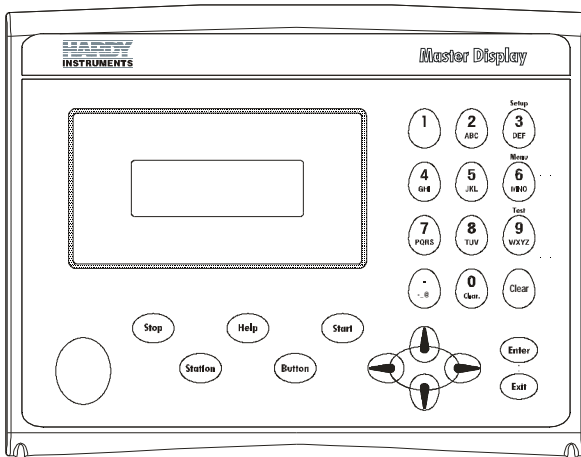

FIG. 341: MASTER DISPLAY/Front PANEL

Help

About Help

As you move through the setup/configuration menus you may on occasion need assistance. If you need help, do the following:

- Step 1. Use the up and down arrows and move the cursor in front of the Menu Item you want help on.
- Step 2. Click the Help button either on the front Panel, a Help Dialog appears. The help dialog tells you what the Menu Item is used for or other descriptive information to help you enter the right parameters for the current menu item.
- Step 3. Push the Exit button to return to the current menu.

Front Panel Display

The Front Panel Display is a 4 line x 20 Alphanumeric character LCD. The screen displays all the menus for Configuring, Calibrating and Operating any HI 3000 Series Instrument. It is important to note that the button functions are based on the selected instrument. Please refer to the specific instrument operating manual for a list and description of button functions or press the "Buttons" button to see a list of the button functions for the selected instrument.

Button Functions

Start Button

The Start Button starts or restarts a process.

Stop Button

The Stop button if pressed once will pause a process. If the Stop Button is pressed twice it stops the process.

Help Button

The Help button displays a Help message for the current Menu item (the Menu item in front of the cursor) that is displayed. In Standby the Help button does not display a Help message.

Station Button

The Station button selects a station (instrument) on the network. It is important to note, when you select an instrument the buttons on the front panel of the Master Display function exactly the same as the buttons on the front panel of the selected instrument except for the "Station" button and "Buttons" button.

Buttons Button

The Button key provides a list of the buttons and their functions that are available when selecting a each HI 3000 Series instrument. For example if you select an HI 3030 Weight Controller the buttons list would indicate that the Tare Value is selected by pushing alphanumeric button #7. (See Fig. 342) If you selected an HI 3010 the buttons list would indicate that Cycle is selected by pushing alphanumeric button #7. (See Fig. 343)

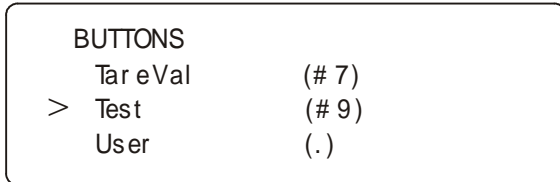

FIG. 342: HI 3030 BUTTON CONFIGURATION

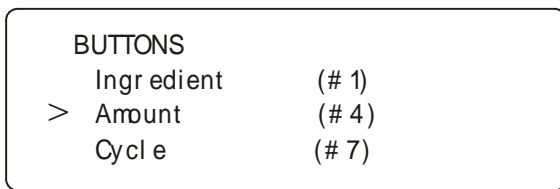

FIG. 343: HI 3010 BUTTON CONFIGURATION

Setup/3/DEF Button

The Setup button assumes the Setup parameters of the selected HI 3000 Series instrument.

Test/9/WXYZ Button

The Test button assumes the Test parameters of the selected HI 3000 Series instrument.

Setting the IP Address

Use the IP Setup program on the Web Browser. See “Setting or Changing the IP Address using the Ethernet” in the Cabling Section of this manual for complete instructions.

Installing the HI 3001

For installation instructions please go to the HI 3010 or the HI 3030 Service Manuals, Chapter 3: Installation. For cabling installation instructions for network cards go to the HI 3000 Installation and Operation Manual, Cabling Section.

Selecting an Instrument on the Network

Step 1. Press the Station button. The Master Config. display appears. (See Fig. 344)



FIG. 344: MASTER CONFIGURATION DISPLAY/HARDY 3030 WEIGHT CONTROLLER AT IP ADDRESS 192.168.110.24

Step 2. Press the left or right arrow buttons to scroll through the list of HI 3000 instruments that are currently connected to the network. When you have found the instrument you want to monitor or configure stop.

Step 3. Press the Enter button. The Main Menu of the instrument you have selected appears. (See Fig. 345) In our example it is the Summary display of an HI 3030 Weight Controller.

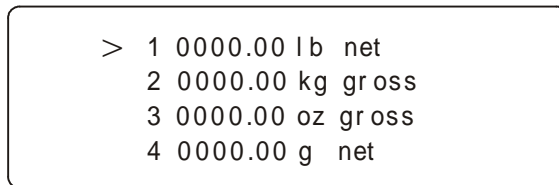

FIG. 345: SUMMARY DISPLAY/HI 3030 WEIGHT CONTROLLER

Step 4. Press the “Button” button. The Button Menu appears with a list of all the buttons for the instrument to which you are connected.

Step 5. Use this list when you want to activate a button that does not appear on the front panel.

Step 6. Now the instrument you are connected to can be configured and operated from the Master Controller HI 3001.

Software Downloads for HI 3000 Series

Software downloads are generally done for one of the following reasons:

- Publication of a Technical Bulletin
- Recommendation from Technical Support or Hardy Web Tech

Step 1. In a web browser, go to www.hardysolutions.com/3000series/webserver/3000support/

[downloads/downloads.php](#) to open the 3000 Series Download page.

Hardy Auto Update	Let's you update HI 3000 Series firmware
IP Setup	Let's you set the IP address of your HI 3000 Series unit
HI 3010 Filler/Dispenser Firmware	Latest firmware (Version 2.10.00)
HI 3030 Weight Controller Firmware	Latest firmware (Version 2.13.00.00)
HI 3600 Machine Monitor Firmware	Latest firmware (Version 2.6.02)
HI 3300 Tension Controller Firmware	Latest firmware (Version 2.7.01.0000)
Master Firmware	Latest firmware (Version 2.4)
EDS Files	Download EDS Control File Download EDS Control File Download EDS Control File Download EDS Control File
GED Files	Program GED
Hardy Modbus-Link	Modbus-Link

FIG. 346 DOWNLOADS PAGE

- Step 2. Select the type of software to download.
- Step 3. Find and start the Auto Update.exe program.
- Step 4. Click Find to search for and list the units that are online on this network.
- Step 5. Select the IP address of the unit you want to upgrade.
- Step 6. Click Browse to find and select the file you downloaded..
- Step 7. With both the IP address and file selected, click Update. When asked for a User Name, enter hardy, and for Password use updatepass (all lowercase) and click OK. A percent complete bar will show the progress of the upgrade followed by a screen indicating the programming is complete.

NOTE: If Update does not display the Password screen, your program file may have too long of a path from the root directory. Try moving your files up to your root directory and run again.

- Step 8. Cycle power on your HI 3000 series instrument.

GLOSSARY OF TERMS

ACCURACY	Closeness of a reading to the actual value of the quantity being measured.
ALARM	Indication of a tolerance deviation.
APPURTENANCE	Any added equipment other than the weigh vessel, platform scale or feeder. Pipes, Valves etc.
BAUD RATE	Baud rates are used as a measure of how fast serial data is transmitted. (BIT/SEC). The higher the number the faster the data is sent between 2 devices.
BI-DIRECTIONAL	A capability used to transmit data in either direction at the same time, for example: to or from the instrument
CAPACITY	The maximum weight that can be placed on a scale or balance.
CHECK WEIGHING	Comparing a weight against limits to determine if the weight is within preset limits.
CLEAR KEY	A key used to clear data or formats entered into a menu.
DEAD BAND	A value used to prevent relay chatter once the setpoint is reached.
DEAD LOAD	Weight of hopper assembly or platform assembly sitting on top of load cells.
DECIMAL POINT POSITION	Menu item used to set the decimal point position for all display readouts.
DISPENSER	Dispensing is a Loss-in-Weight process. The Dispenser measures the weight loss out of a vessel until a pre-configured weight set point has been reached
DISPLAY	A device used to show information from the instrument.
ENGINEERING UNITS	Pounds (lbs), Kilograms (kg), ounces (oz, grams (g)
ELECTROSTATIC DISCHARGE	Electrostatic Discharge is an electric charge (static electricity) which occurs when an electrically charged object such as a person, touches an HI 3000 Series Instrument. to avoid damage to personnel and to the unit, a grounded static control wrist strap should always be worn when opening and/or servicing an instrument.
E-MAIL	Short for electronic mail, the transmission of messages over communications networks.
ENTER KEY	This key is used to accept user input into the memory.
EPROM	Electrically Programmable Read-only Memory.
ERROR	A message that indicates an unacceptable input has been entered.
EVEN	A parity configuration.
EXCITATION	DC voltage supplied to the load cell for power.
FILLER	Filling is a Gain-in-Weight process. The Filler measures the weight gain into a vessel until a pre-configured weight set point has been reached.

FULL-SCALE	Full scale input as defined by instrument and load cell parameters. Example: 3mV/V load cell @ 10 volts = 30mV full scale.
GRADUATION SIZE	Minimum increment displayed by the instrument
GROSS WEIGHT	An overall weight exclusive of tare deductions. Weight of material plus container.
IBC	Intermediate Bulk Container
INTERNET	The Internet is a system of linked networks that are worldwide in scope and facilitate data communication services such as remote login, file transfer, electronic mail, the World Wide Web and newsgroups.
INTRANET	An intranet is a private network utilizing Internet-type tools, but available only within that organization.
KILOGRAMS	A unit of mass in the metric system. Equal to 1000 grams or 2.2046 pounds. "kg" represents kilograms on the display.
LEVELLING	The procedure that sets the scale so that a scale platform is exactly horizontal (level).
LED	Light Emitting Diode. these are used as status indicators.
LOAD CELL	A device which produces output signal proportional to the applied weight or force. Also called a strain gauge.
MENU	A set of prompts used to configure the instruments.
MENU DRIVEN	Operational prompts supplied in common language via the system display to guide an operator through a procedure.
MICROPROCESSOR	A semiconductor device that performs control, input/output, arithmetic and logical operations by executing instructions obtained from memory sources.
MIDPOINT LINEARITY CORRECTION	Allows operator to "BEND" the response of an instrument to match a non-linear input.
MOTION	The amount of allowable deviation between consecutive readings before a weight is accepted as being complete.
NEMA 4	An enclosure that is water tight, dust tight and usable both indoors and outdoors. Will protect the enclosed equipment against splashing water, seepage of water, falling or hose-directed water and severe external condensation.
NEMA 4X	An enclosure that is water tight, dust tight and usable both in doors and outdoors. Will protect the enclosed equipment against splashing water, seepage of water, falling or hose directed water and severe external condensation. Corrosion Resistant.
NODE	A node is an active device connected to the network, such as an HI 3000 Instrument, computer or a printer. A node can also be a piece of networking equipment such as a hub, switch or a router.
NET WEIGHT	Gross Weight minus the Tare Value.
NON-LINEARITY	A deviation of an instrument response from a straight line.

NUMBER OF READINGS PER AVERAGE	The number of weight readings used to compute the displayed weight.
ODD	A parity configuration.
OPTION	A device not supplied with a standard instrument.
OPTION SLOT	A location used to install an option card.
PARITY	A binary digit error correction appended to an array of bits to make the sum of all the bits always odd or always even. The quality of being either odd or even. The fact that all numbers have a parity is commonly used in data communications to ensure the validity of data.
POUNDS	A unit of mass in the Avoirdupois System. Equal to 16 ounces or 0.4536 kilograms.
POP	Short for Post Office Protocol , a protocol used to retrieve e-mail from a mail server.
PRACT	The number of units above or below the set point value of which the relay will trip. Use as an “in flight” compensation value.
PREVIOUS KEY	A key used to step back through menus.
PROMPTS	Instructions or options presented in a menu by the instrument.
PROTOCOL	Network protocols are standards that allow computers to communicate. A protocol defines how computers identify one another on a network, the form that the data should take in transit, and how this information is processed once it reaches its final destination.
RAM	Random-Access-Memory. Read/write memory out of which the microprocessor can both write and read data.
RATE OF CHANGE (ROC)	A measure of the rate at which weight is changing. For example: If 100 pounds were dispensed in 1 minute, the rate of change (ROC) would be 100 lb/minute.
REPEATABILITY	The maximum difference between readings for repeated readings under identical conditions. (Also called reproducibility)
RESOLUTION	Resolution is the value of the finest division of the scale.
ROM	Read-Only-Memory. This permanent, non-volatile memory gives the processor instructions and cannot be altered.
RTS	Request to send an RS-232C level, signaling a readiness to send.
RXD	Received data at a serial port. Accepts RS-232C data signals.
SCALE CAPACITY	The maximum amount of weight the scale is capable of supporting. (Live load plus dead load).
SECURE MEMORY MODULE (SMM)	The Secure Memory Module stores and protects vital information from corruption. The SMM also allows the transference of data from one instrument to another with no re-calibration or re-configuration necessary.

SET POINT	Ordered weight of a particular ingredient. Weight reading at which a relay will be actuated.
SPAN	the total amount of test weights used (placed on the scale) when performing a "Traditional Calibration".
TAG	Another name for the Secure Memory Module
TARE	Artificial zeroing of the weight hopper so that a net weight can be displayed. The action of adjusting out the known weight of the container from the total indicated weight, so that the indicator reads net weight directly.
TEMPERATURE COEFFICIENT	the change in indication due solely to a change in temperature from a reference temperature. Expressed as a percentage of span value for a specified temperature change.
TIME BASE	Time in seconds between values subtracted to determine rate-of-change.
TOKEN	In programming languages, a single element of a programming language. For example, a token could be a keyword, an operator, or a punctuation mark. Used to format E-mails or to enter parameters into an Custom E-mail.
TRANSMITTER SPAN	Value the transmitter puts out with the maximum weight on the load cell.
TRANSMITTER ZERO	Value the transmitter puts out with the minimum weight on the load cell.
TTL	Transistor-Transistor Logic
TXD	Transmit Data
UPDATE RATE	Number of times per second a new weight reading is taken.
ZERO	Weight reading once the dead load has been offset.
ZERO CALIBRATION	Offset of the value of the dead load of the weight hopper.
ZERO TOLERANCE	The number of graduations from zero that will be accepted as zero by the instrument.

Symbols

“Clean” Primary Line 11
 “ETHERNET-MODULE Generic Ethernet Module” 84
 “Offline” Mode 83
 “SETUP” 14
 “www.Link
 HI 3000 Series Online Support Site” 15
 *.gsd File 49

Numerics

10/100 base T 1
 10/100 Base T Ethernet Card 37
 1024 62
 10BaseT Cable Pinouts 35
 14 AWG Power Line 11
 3000 Controllers are Masters on DeviceNet, 85
 3600 Modbus.xls File 60
 3rd party I/O 1
 5 Digital Inputs 11
 9 Terminal Block 12

A

About Custom E-Mail 91
 About Discrete Remote I/O Mapping 9
 About Help 103
 About OPC Client 72
 About Tokens 91
 Access Names Dialog Box 75
 Access Text Field 76
 Activating ControlNet and Setting the ControlNet Node
 Address from the Web Page 20
 Add Access Names Dialog Box 75
 Additional Field Devices Folder 50
 Addr. 24
 Address Error 60
 Address field in the Browser 37
 Advanced Mapping Web Page 93
 AdviseEx Button 74
 Alphanumeric Character LCD 103
 Analog Option Card 28
 Analog Output Option Card Installation 28
 Analog Panel 29
 Animation Links 75
 ANYBUS-S PDP 50
 Application Communication Status LED 28
 at symbol (@) 91
 Automap on Add 46
 Available Devices Field 45

B

Basic Alarm E-mails 87
 Baud Rate 17
 Baud Rate Selection 17

Index

Binary Formats Tab 63
 Blind Remote 15
 Boolean 85
 Browser 1, 35
 Building a Scanlist in RSNetWorx 45
 Button Functions 103
 Byte Count Error 60

C

C2[®] Load Point Connection 12
 Cable Color Code 12
 Cable color Code for Non-C2 Load Points 12
 Cable Specification 27
 Cabling Guideline 26
 Cancel 78
 Card Connector 23
 CD ROM 15
 Chains and Triggers Page 70
 Chains and Triggers Tab 70
 Chan Field 80
 Check Mark 78
 Class A Address 87
 Class B Address 87
 Client 56
 Client (Hardy Modbus-Link) 60
 Clr Button 90
 Communication Adapter Folder 43
 Communication Cables 103
 Configurable I/O Server 61
 Configuration - Hardy-Link Page 38
 Configuration - Options Page 55
 Configuration Menu 13
 Configuration of Host Message 72
 Configuration-Hardy Control-Link Page 77
 Configuring Custom E-Mail 91
 Configuring EtherNet/IP Using RSLogix5000[®] 83
 Configuring Standard E-Mail 90
 Configuring the E-Mail Server 88
 Connection Parameters 84
 Connection Pull Down Menu 56
 Connectivity 1
 Controller Tags List 85
 ControlNet Connection and Setup 19
 ControlNet Network Setup 46
 ControlNet Option Card Installation 18
 Create Button 73
 Create Connection Dialog Box 73
 Current Mappings Text Field 80
 Current Output 29
 Custom Event E-mails 87
 Customer E-Mail Page 91
 Cycle Power 50

D

Data Transmission Baud Rate(s) Required. 49
Data Type Pull Down Menu 66
Data-INT 84
Default Address
 192.168.110.99 15
Default IP Address 14
Default LOW 101
Default Word 58
Descartes Omniserver™ 61
Description Text Field 84
Destination and Source 58
Details Radio Button 76
Device Pull Down List 65
DeviceNet 1, 11, 35
DeviceNet Cable 16
DeviceNet Connection and Setup 16
DeviceNet Connector 16
DeviceNet Control Software 1
DeviceNet Network Setup 40
DeviceNet Weigh Modules 45
Digital Input Wiring 11
Dip Switch Settings 4
Discrete Remote I/O Mapping 9
DNS 88
DNS IP Address 90
DNS Server Address 89
DNS Server address 87
Documentation CD 60, 69
Domain Name 91
Domain Name System 88
Downloads/IP Setup 15
DPD File 70
Drop Line 26
Dry Contact Switch 11

E

EDS File Installation 43
EDS File Installation Test Results Dialog Box 42
EDS Options Dialog Box 41
EDS Wizard 41
EDS Wizard Dialog Box 41
Electronic Key 46
E-mail # 91
E-mail Addresses 87
E-Mail Configuration Web Page 88
E-Mail Message Text 91
Enabling Mod-Bus in the HI 3000 Module 55
Enter Button 17
Enter Parameters Button 99
Enter Password Dialog Box 98
Enter Password Display 100
Enter User Name Display 99
Enter Value Display 59
Error Page 98
Ethernet 1, 14

Ethernet (TCP/IP) 15
Ethernet 10/100 Base T 35
Ethernet Adapter 35
Ethernet Cable Connection and Setup 13
Ethernet Cables 11
Ethernet Card 19, 35
Ethernet Connection 1, 13
Ethernet Crossover Cable 19, 35
Ethernet Network 35
Ethernet Sub-Menu 14
EtherNet/I/P Card Panel 23
EtherNet/I/P Option Card 23
Ethernet/IP I/O 24
EtherNet/IP I/O Menu 24
EtherNet/IP Module/Bridge 83
EtherNet/IP Page 25
EtherNet/IP RJ-45 Connectors 23
EtherNet/IP™ Option Card Installation 22
ETHERNET-MODULEHARDY 85
Extranet 1

F

Factory Suite 72
FI00 66
Fieldbus Diagnostics 28
Fieldbus Off-Line 28
Fieldbus On-line 28
Filler/Dispenser Controller 11
Filling Operation is a Gain-in-Weight Process 105
Final Task Summary Dialog Box 42
Float In 0.0 Value 66
Float Inverse 58
Float Variable 4 57
For HI 3010 Only 16
For HI 3030, HI 3600, HI 3300 17
Four Octets 87
Four-Byte Float 64
Function Not Supported 60

G

Gate Address 24
Gateway 87
Gateway IP Address 90
General Folder 50
Generic Ethernet Module 84
Glossary of E-Mail Terms 87

H

Hardware Catalog 50
Hardy *.GDS File 26
Hardy Control-Link 85
Hardy control-link 37
Hardy Control-Link Float Out 80
Hardy Control-Link Float Out Word 2 81
Hardy Control-Link Network 38
Hardy Control-Link Page 39

Hardy EDS File 16, 19, 41
Hardy Filler Icon 43
Hardy Filler Property List 43, 45
Hardy Instruments Technical Support Department 11
Hardy Instruments, Inc listed under Vendor 42
Hardy Link Ethernet Network 37
Hardy Modbus-Link 56
Hardy Modbus-Link .exe File 56
Hardy Modbus-Link Display Appears 56
Hardy Modbus-Link Icon 56
Hardy Modbus-Link Software 56
Hardy OPC Server 61
Hardy Output Table 92
HardyFloat 73
HardyFloat Topic Icon 65
HARDYOPC_FLOAT 65
Help 103
Help Button 103
Help Dialog 103
Help Wizards 1
HFO - Float Variables, Word 4 60
HFO4= 57
HI 3000 Resources Web Page 56
HI 3000 Series Input and Output Sizes 54
HI 3000 Series instrument Home Page 38
HI 3000 Series Network 35
HI 3000 Series Network Configurations 35
HI 3000 Series Service Manual 11
HI 3000 Series(ANYBUS) Module 51
HI 3601 Machine Monitor 62
HI Series 3000 Home Page 98
High Level Menus 97, 99
High Password Field 99
High Security 97
Home Page 20
Host Message Configuration 68
HW Config Dialog Box 52

I

I/O Block 1
I/O Mapping 46
I/O Module 1
IEEE MSB...LSB 64
IMAP 88
IN/OUT
 128Byte (64 word) 51
Incorrect Number 98
Information CD 72
Inhibit Module 84
Initial Value Page 66, 67
Initial Value Tab 66, 67
Initial Value Text Field 67
Initializaiton Process 49
Initialization Procedures 50
Input and Output Size Setup 51
Installation Instructions 11
Installing Hardy Modbus-Link 56

Installing MOD-BUS 55
Installing the Cord Grip Assemblies 30
Installing the HI 3000-RC Rear Cover 32
Installing the NEMA 4 Plug 30
Installing the RIO Option Board 4
Instrument Home Web Page 88
Instrument Icon 43
Instrument IP Address 90
Instrument Name Text Field 78
Instrument Selection 78
Instrument Selection Pull Down List 38
Instruments IP Address 14
Interface 1
Internet 1, 35
Internet Explorer Propeties Dialog Box 37
Internet Options Icon 37
Intranet 1
IP Address 14, 38, 78
IP Address Field 39, 84
IP Address Text Field 25, 78
IP Addresses 15
IP Setup 15
IPSetup.exe 15
Item 73
Item Definition Dialog Box 66
Item Dialog Box 73
Items Definition Setup 65

J

J9 terminal Block 12
-JB Option Wiring 13
Jump to Source Page Button 80

K

Key to enable 55

L

LAN 35
LapTop 1, 19, 35
Laptop Ethernet card 35
Last Octet 36
LED Indicators 28
LED Status Indicators 22
List of Setpoints 91
Load Cells 11
Load Point Cables 103
Load Point Connections 12
Log On 99
Log On Procedures 99
Logging on from the Front Panel 99
Logviewer Dialog Box 73
Low Security Level 97

M

Mail Server 89
Mail Server IP Address 89

Mail to Address 1 90
Mail User ID 90
Mail User ID (Account) Name 90
Main Network Cable 26
Main Page 42
Manual Button 103
Map
 Text Field 57
Map Button 58, 82
MAP Terms 92
Map Key 85
Mapping Parameters 79
Mapping Setup 79
Mapping Setup 1 Page 79
Mapping Setup Page 2 80
Mapping Web Page 57
Mask Address 24
Materials Required 35
Maximum Message Length 63
Medium Password Field 99
Message Name Text Field 71
Microsoft® Outlook® 95
MOD-BUS - TCP/IP Over Ethernet 55
Modbus Client 60
Modbus Float In (MFIO) 58
Modbus Key 55
Modbus Key Text Field 55
Modbus-Options Page 55
Module Properties - EtherNet_Bridge (ETHERNET-MODULE 1.1 84
Monitoring 1
MSB...LSB 64

N

Name Text Field 74
Network 15
Network Administrator 15, 24, 35, 88
Network Dialog Box 36
Network Icon 36
Network Pull Down List 57, 79
New IP Address 25
New Window 74
No Connection 57
Node 39, 78
Node 5 Button 78
Node Address 21, 36, 50
Node IP Address 39
Node IP Address Field 78
Node Text Field 21
Non-Boolean 85
Non-C2 Load Cell Connection 12
Non-C2 Load Point Connections 13
Non-Low Security Level 97

O

Object Type Dialog Box 75

Octet Ranges 87
OLE for Process Control (OPC) 60
OLE technology (DCOM) 2, 60
Omniserver Configuration 61
Omniserver Folder 70
OPC EDS File 69, 72
OPC I/O Server Quick Start Manual 61
OPC Network Setup 60
OPC Server 61
OPCMiscellaneous DPD 70
Option Slot #0 28
Option Slot #1 28
Options Submenu 53
OPTO22 Solid State Relays 12
OSI Model 54
Output Relay Wiring 12

P

Parameter Number 92
PARAMETERNUMBE 91
Password List 98
PCs 35
Ping Button 62
Ping Tool 40
PLC 52
PLCs 35
POP 88
Port Hub 37
Port Text Field 62
Power and Relay Circuit Card 11
Power Input J1 11
Pre-Initialization Procedures 49
Process Data Field 80
Process Data Pull Down List 80, 81
Product Home Page 37
Profibus Cable with DB9 Serial Connectors 26
Profibus Configuration Page 54
Profibus Connection and Setup 26
Profibus DP Network 49
Profibus I/O 53
Profibus International 49
Profibus Option Card 26, 28
Profibus Option Card Installation 26
Profibus standard Type A Cable 27
Profibus Web Site (<http://www.profibus.com/libraries.html>) 26
Profibus-DP .GSD File 49
Profibus-DP Cable Specifications 49
PROFIBUS-DP EN 50 170 Specification 26
Profibus-DP Network 50
PROFIBUS-DP Network Setup 49
Properties Button 36
Protocol Definition Dialog Box 63
Protocol Item List 74
Protocol Settings 63
Protocols Icon 63

Q

Qualcomm's Eudora™ 95

R

Read/Write Multiple Registers 59
Rear Cover Installation 29
Received Tab. 71
Registration Dialog Box 41
Remote I/O Board Cable Termination Dip Switch Configuration 4
Remote I/O Configuration Procedures from the Front Panel 5
Remote I/O Configuration Procedures from the Web Page 7
Removing the Analog Option Card 29
Removing the ControlNet Option Card 19
Removing the Cord Grip Assembly 32
Removing the EtherNet/IP Option Card 23
Removing the NEMA 4 Plug 30
Removing the Profibus Option Card 28
Removing the Remote I/O Option Card 5
Reply Timeout 62
Report Any Damage 11
Request Error 60
Request/Reply PDUs 54
Request/Reply Protocol 54
Requested Packet Interval (RPI) Field 84
Reserved System Port 502 54
Response OK Pop 60
RJ45 Connector 1
Rockwell Software Folder 41
Rotary Switches 27
RS 232 Connection 12
RS 232 Connection Pinout 13
RS-232 1
RSLogix Setup for HI 3000 Series Instruments with ControlNet Option Card 46
RSLogix™ 16
RSNetWorx 41, 46
RSNetworx 85
RSNetWorx Manual 46
RSNetWorx Setup for HI 3000 Series Instruments 41
RSNetWorx™ 1, 16, 19
Runtime 77

S

Save Settings Button 40, 78
Scanlist 46
Scanlist Configuration 46
Scanlist Page 45, 46
Scanlist Tab 45
Schedule the Network Using RSNetWorx for ControlNet 47
Scratchpad Pull Down Menu. 57
SECURITY 97
Security Level Status Display 100

Security Levels 97
Security Levels Setup 99
Security Menu 97
Security Page 99
Segment (First Three Octets) 36
Select a Unit Field 15
Select Destination Module Dialog Box 51
Select EDS File Dialog Box 41
Select Module Type Dialog Box 84
Select Tag Dialog Box 76
Selecting the ControlNet Node Address from the Front Panel 47
Selecting the ControlNet Node Address from the PDA 54
Selecting the ControlNet Node Address from the Web Page 48, 53
Selecting the Profibus Node Address from the Front Panel 52
Selecting the Profibus Node Address from the PDA 54
Selecting the Profibus Node Address from the Web Page 53
Send Setup to Node 40
SendDataTrigger 71
Server 56
Server (HI 3000 Module) 60
Set Parameters Button 22, 25
Setting a Medium or High Security Level 97
Setting Node Addresses 38
Setting up Filters in E-mail Applications 95
Setting Up OPC Communication with a Client 72
Setting up Passwords from the Browser 98
Setting up Passwords from the Front Panel 97
Setting Up the EtherNet I/P Address from the Front Panel 23
Setting Up the EtherNet I/P Address from the Web Page 24
Setup Menu 89
Setup Submenu 14
Siemens PLC 50
Siemens Step 7™, Simatic Manager 26, 50
Simatic Manager 49
Simple Ethernet Network 35
Simple Mail Transfer Protocol 88
Smart Devices 1
SMTP 88
Software Requirements 26
Standby Display 98
Standard E-Mail Web Page 91
Standard Ethernet Cables 38
Standard Format E-mail 87
Standby Display 14, 97
Start Button 103
Station Address Dialog Box 52
Stop Button 103
Subject Text Field 92
SuiteLink 76

- T**
- Tagname Dictionary 76
 - Tagname Dictionary Dialog Box 76
 - Talk Check Box 78
 - Talk Check Boxes 40
 - Tare Value 4
 - TCP/IP Connection Display 56
 - TCP/IP Dialog Box 36
 - TCP/IP Over Ethernet. 55
 - TCP/IP Stack 54
 - Technical Support 11
 - Terminal Blocks 13
 - Testing the Custom E-Mail 94
 - Text Tool 75
 - The Profibus I/O Menu 53
 - The Protocols Dialog Box 63
 - The Topic Definition Dialog Box 65
 - To Address 91
 - Tokens 91
 - Top Level Menus 97
 - Topic Name 76
 - Topic Name Text Field 76
 - Topics Configuration 64
 - Translations Tab 64
 - Trigger Point Pull Down List 71
 - Trunk Line 26, 49
 - Two-Byte Integer Pull Down List 64
- U**
- UDP Data Regarded As Float 65
 - UDP_DATA 71
 - Unauthorized Personnel 97
 - Understanding IP Addresses 87
 - Unique IP Address 14
 - Universal Power Supply 11
 - Unmap Button 85
 - Unpacking 11
 - Unsolicited Message Definition 71
 - Unsolicited Message Definition Dialog Box 71
 - Unsolicited Messages 71
 - Update Interval Text Field 65
 - UR Dialog Box 50
 - User Name 91
 - User/. Button 100
 - Using Mod-Bus with Excel® 60
- V**
- Value Display 75
 - Value Error 60
 - Variables Page 65
 - Variables Tab 65
 - View ControlNet Configuration 21
 - View EtherNet/IP Configuration. 25
 - Voltage Output 29
 - VPN (Virtual Private Network) 1
- W**
- Web Server 1
 - Web-Link 15
 - Window Properties 74
 - Windows to Open Dialog Box 74
 - Winsock Device 62
 - Wireless IR 35
 - Wireless Servers 35
 - Wonderware InTouch 72
 - Wonderware WindowMaker 74
 - Wonderware WWClient 73
 - Wonderware® 72
 - Write FO00...FO62 68
 - Write Multiple Registers 59
 - WWClient Table of Items 74



9440 Carroll Park Drive, San Diego, CA 92121
Telephone: 1-800-821-5831 FAX: (858) 278-6700
Web Address: <http://www.hardysolutions.com>